

TOSHIBA

gigabeat F60 / F40 / F20 / F10

Toshiba Mobile Audio Player

Model: MEGF60 / MEGF40 / MEGF20 / MEGF10

Owner's Manual

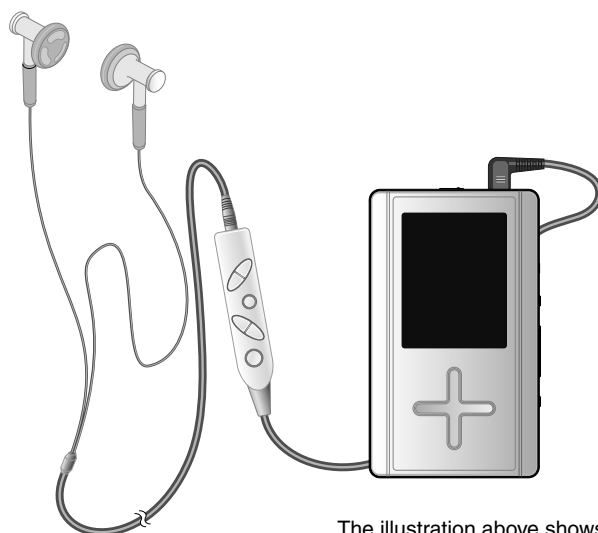

The illustration above shows
the image of the MEGF60, MEGF40.

- Thank you for purchasing a Toshiba gigabeat Mobile Audio Player.
- Please read this manual carefully before using your gigabeat Mobile Audio Player to ensure correct use of the product.
- After reading the manual, keep it for future reference.

© TOSHIBA CORPORATION 2005



Printed in China
GX1C0008CA10
PX1C0008CAAA

Product Name : MOBILE AUDIO PLAYER

Model Number(s) : MEGF60, MEGF40, MEGF20, MEGF10

FCC Notice

This equipment has been tested and found to comply with the limits for a Class B digital device, pursuant to part 15 of the FCC Rules. These limits are designed to provide reasonable protection against harmful interference in a residential installation. This equipment generates, uses and can radiate radio frequency energy and, if not installed and used in accordance with the instructions, it may cause harmful interference to radio communications. However, there is no guarantee that interference will not occur in a particular installation. If this equipment does cause harmful interference to radio or television reception, which can be determined by turning the equipment off and on, the user is encouraged to try to correct the interference by one or more of the following measures:

- Reorient or relocate the receiving antenna.
- Increase the separation between the equipment and receiver.
- Connect the equipment into an outlet on a circuit different from that to which the receiver is connected.
- Consult the dealer or an experienced radio/TV technician for help.

NOTE

Only peripherals complying with the FCC Class B limits may be attached to this equipment. Operation with noncompliant peripherals or peripherals not recommended by Toshiba is likely to result in interference to radio and TV reception. Changes or modifications made to this equipment not expressly approved by Toshiba or parties authorized by Toshiba could void the user's authority to operate the equipment.

This device complies with part 15 of the FCC Rules. Operation is subject to the following two conditions :

- This device may not cause harmful interference.
- This device must accept any interference received, including interference that may cause undesired operation.

Contact:

Toshiba America Consumer Products, L.L.C.

82 Totowa Road

Wayne, NJ 07470

(973) 628-8000

Industry Canada Requirement

This Class B digital apparatus complies with Canadian ICES-003.

Cet appareil numérique de la classe B est conforme a la norme NMB-003 du Canada.

▲ WARNING

Handling the cord on this product will expose you to lead, a chemical known to the State of California to cause birth defects or other reproductive harm. ***Wash hands after handling.***



Tested To Comply
With FCC Standards
FOR HOME OR OFFICE USE

Safety Precautions

Safety icons

This manual contains safety instructions that must be observed in order to avoid potential hazards that could result in personal injuries, damage to your equipment, or loss of data. These safety cautions have been classified according to the seriousness of the risk, and the icons highlight these instructions as follows:

▲ WARNING Indicates a potentially hazardous situation which, if not avoided, could result in death or serious injury.

▲ CAUTION Indicates a potentially hazardous situation which, if not avoided, may result in minor or moderate injury.

CAUTION Indicates a potentially hazardous situation which, if not avoided, may result in property damage.

NOTE Provides important information.

Welcome

Getting Ready

Using the Product

Other Helpful Information

Safety Precautions (Continued from the previous page)

Precautions for Use

▲ WARNING Should you notice any abnormality such as odor, smoke or overheating, turn off the power and disconnect the AC adapter. Continuing to use the product may result in fire, electric shock or burn, possibly resulting in serious injury.

▲ WARNING If water or other foreign object should enter the equipment, turn off the power and disconnect the AC adapter. Continuing to use the product may result in fire or electric shock, possibly resulting in serious injury.

▲ WARNING If you have dropped the product or damaged its top panel, turn off the power and disconnect the AC adapter. Continuing to use the product may result in fire or electric shock, possibly resulting in serious injury.

▲ WARNING Do not disassemble, modify or repair the product. It may result in fire or electric shock, possibly resulting in serious injury.

▲ WARNING Do not cause metals to contact the product or any inflammable objects to enter the product. Do not cause foreign objects to enter or drop into the holes in the terminals and other openings or gaps. It may result in fire or electric shock, possibly resulting in serious injury.

▲ WARNING Turn off the power and refrain from using the product on an airplane, in a hospital or other place where use of the product is prohibited. Using the product in these places may affect systems of operation, the functioning of medical equipment, resulting in an accident and possibly serious injury.

▲ WARNING Do not use the product in a place that is exposed to water. Doing so may result in fire or electric shock possibly resulting in serious injury. Be particularly cautious when using the product in rain, snow or on beach or other waterfront area.

▲ WARNING Do not use the product in a bathroom or shower. Doing so may result in fire or electric shock possibly resulting in serious injury.

▲ WARNING Do not touch the power cable or main unit while in a thunderstorm. Doing so may result in electric shock possibly resulting in serious injury.

▲ WARNING Do not operate the product while walking, driving a car, or riding a motorcycle. You may fall or cause a traffic accident, possibly resulting in serious injury. You cannot hear sounds from the surrounding environment, which may lead to an unexpected accident, possibly resulting in serious injury.

▲ WARNING Be careful not to let a small child play with the plastic bag used to wrap the product. The child may place the bag over his/her head or swallow it, resulting in suffocation.

▲ WARNING Should you notice leaking fluid or odor from the product, immediately move it away from any source of fire. The fluid from the product is leaking from the built-in battery. In the event of battery leakage, the fluid may ignite and cause explosion, possibly resulting in serious injury.

▲ WARNING Do not charge the built-in battery other than by the specified method. Doing so may result in fire, explosion or electric shock, possibly resulting in serious injury.

▲ WARNING Do not charge or discharge the product near fire or under the hot sun. The built-in battery may leak, resulting in ignition or explosion, possibly resulting in serious injury.

▲ WARNING Do not use the product in a humid or steamy environment, nor use it in a place that is dusty or subject to lamp soot. Doing so may result in fire or electric shock, possibly resulting in serious injury.

▲ WARNING Remove the cables when moving the product. Failure to do so may damage the cables, resulting in fire or electric shock, possibly resulting in serious injury.

▲ WARNING Disconnect the AC adapter before cleaning the product. Cleaning the product with the AC adapter still connected may result in electric shock, possibly resulting in serious injury.

▲ WARNING Do not play the supplied CD-ROM on a music CD player. Doing so may damage the headphones or speaker or injure your ears, possibly resulting in serious injury.

▲ WARNING Should you discover leakage from the product, do not touch the fluid. The leakage from the product is fluid from the built-in battery. If battery fluid should enter the eye or contact the skin, eye injury or skin damage may result. If battery fluid should enter your eye, rinse thoroughly with clean water and seek immediate medical advice. If battery fluid should adhere to your skin or clothes, immediately rinse it away with clean water.

▲ WARNING Do not place the product in a hot place. Placing the product under direct sunlight, in a closed car, near a stove, etc., may result in heat generation or fire, possibly resulting in serious injury. The product may also break possibly resulting in serious injury.

▲ WARNING Do not subject the display surface to impact. Doing so may result in a damaged display, broken glass or leaking fluid possibly resulting in serious injury. If fluid should enter your eye or adhere to your body or clothes, immediately rinse it away with clean water. If fluid should come in contact with your eye, rinse with clear water and seek immediate medical advice from a doctor.

▲ WARNING Store the product in a place out of the reach of small children. Failure to do so may result in injury or accident.

Welcome

Getting Ready

Using the Product

Other Helpful Information

5

Safety Precautions (Continued from the previous page)

▲ WARNING Do not place the product on, or cover it with, a cloth or cushion. The buildup of heat may cause the top panel to deform or result in fire possibly resulting in serious injury. Use the product in a well-ventilated place.

▲ WARNING Do not drop the product or subject it to strong impact. The product may be damaged, or fire or electric shock may result, possibly resulting in serious injury.

▲ CAUTION Do not swing the product around when transporting or carrying it. The product may strike a person or object, resulting in injury.

▲ CAUTION If you should experience an abnormal sensation on your skin, immediately stop using the product and consult a dermatologist. In rare occasions the materials or surface treatments used in this product may cause itchiness, rash, eczema, etc., depending on the user's physical constitution or health condition.

▲ CAUTION When using the headphones, be careful not to listen at excessive volume. Listening to very loud sound levels may adversely affect hearing ability.

AC Adapter

▲ WARNING Connect the power plug of the AC cable to a power outlet in the home. Using a power source other than 100 to 240 VAC may result in fire or electric shock, possibly resulting in serious injury.

▲ WARNING Do not attempt to disassemble, modify or repair the AC adapter. Doing so may cause fire or electric shock, possibly resulting in serious injury.

▲ WARNING Occasionally disconnect the power plug and clean it if dirt or dust has adhered to the prongs or the mounting surface of the prongs. The insulation of the power plug may decrease, resulting in fire possibly resulting in serious injury.

▲ WARNING Do not cover the AC adapter with a cushion or place it near a heater or on a carpet when the adapter is conducting current. Doing so may result in fire, possibly resulting in serious injury.

▲ WARNING Do not subject the AC adapter's power cable to any of the following:

- Scratching, extending or otherwise modifying, or heating
- Pulling, placing below a heavy object, or pinching
- Bending with force, twisting or bundling

Doing so may result in fire or electric shock, possibly resulting in serious injury.

▲ WARNING Do not use the supplied AC adapter with any device other than the product. Using the AC adapter for any other purpose may result in fire or damage, possibly resulting in serious injury.

▲ WARNING Insert the power plug firmly into the power outlet. If the power plug is not fully inserted, fire or electric shock may result, possibly resulting in serious injury.

▲ WARNING When removing the power plug from the power outlet, do not pull directly on the cable. Always hold the plug to remove it. Pulling the plug by the cable may damage the cable or plug, resulting in fire or electric shock, possibly resulting in serious injury.

▲ WARNING Do not connect or disconnect the power plug with a wet hand. Doing so may result in electric shock, possibly resulting in serious injury.

▲ WARNING If the product will not be used for a prolonged period, such as when you are traveling, disconnect the power plug from the power outlet to ensure safety. Should the product experience a circuit failure, fire may result, possibly resulting in serious injury.

▲ WARNING Use the supplied AC adapter and AC cable. Using an AC adapter or AC cable other than the specified part may result in fire, possibly resulting in serious injury.

Welcome

Getting Ready

Using the Product

Other Helpful Information

7

Contents

Welcome

Getting Ready

Using the Product

Other Helpful Information

Welcome

● Safety Precautions	3
● Contents	8
● Welcome	9
● Important Information on Use	10
● AC Adapter	14
● Key Product features	15

Getting Ready

● Product Overview	16
● Names and Functions of the Parts	20
● Display Windows	26
● Charging the Built-in Battery	30
• Direct Charging from the AC Adapter	30
• Charge Using the USB CRADLE	31
• Charge with Connected to PC Using USB Cable	31

Using the Product

● Turning the Power ON/OFF	33
• Turning the Power ON/OFF	33
● Playing Music Tracks	34
• Playing the Track Selected	35
• Stopping Playback	36
• Controlling the Volume	36
• Fast Forward/Reverse	37
• Skip Forward or Back	37
• Skip to the Next Album	37
● Setting the Play Mode	38
● Setting the Equalizer Mode	40
• Adjustments When "USER" Has Been Selected	42
● Bookmarking	44
• Viewing Bookmarked Tracks	45
• Playing All of the Tracks that were Registered to the Bookmark	45
● Playing Back Playlists	46
● Moving Tracks to the Recycle Bin	47
• Viewing Tracks in the Recycle Bin	48
• Deleting Tracks in the Recycle Bin	48
● Viewing Track Information	50
● Playing Intro	51
● Changing Screen Themes	52
● Displaying Images (Photo Viewer)	54
• Set the Full-Screen Display	54
• Running the Slideshow	55
• Setting an Image as the Background	56
● Output of Audio from An Audio System	57
● Backing up Data to the gigabeat	58

Other Helpful Information

● Track Selection and Playback Sequence	60
● Changing/Checking Settings	62
• Setting Time Zone	64
• Setting DATE/TIME	65
● Terminology	66
● Error Message List	67
● Troubleshooting	68
● Specifications	69
● License Information on the Software Used in the TOSHIBA Mobile Audio Player	71
● Limited Warranty	72

Welcome

Contents of the Owner's Manual

This manual describes the basic operations of the gigabeat. For additional information, refer to the Owner's Manual-"gigabeat room".

The information contained in this manual, including but not limited to any product specifications, is subject to change without notice.

Trademarks

- The gigabeat is a registered trademark of Toshiba Corporation. Plus Touch, gigabeat room, and RipRec are trademarks of Toshiba Corporation.
- Microsoft, Windows and Windows Media are either registered trademarks or trademarks of Microsoft Corporation in the United States and/or other countries.
- Pentium is a registered trademark of Intel Corporation and its subsidiaries in the U.S.A. and other countries.
- WOW, SRS and (●) symbol are trademarks of SRS Labs, Inc. WOW technology is incorporated under license from SRS Labs, Inc.
- The product names referred to in this manual may be registered trademarks or trademarks of their respective companies.

Supplied accessories

The gigabeat ships with the following accessories. Confirm that all items are included in the package.

AC adapter

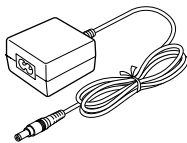

AC cable

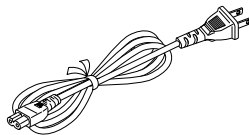

USB CRADLE

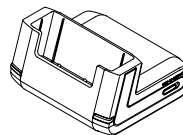

USB cable

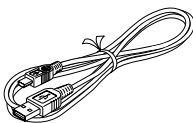

Wired remote control
(Supplied with the
MEGF60, MEGF40)

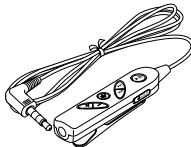

EARBUDS

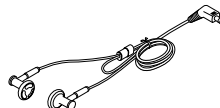

Software CD-ROM
(TOSHIBA gigabeat room
Applications Software CD)



- Owner's Manual (this document)
- Owner's Manual-"gigabeat room"
- QUICK START GUIDE
- End-User License Agreement
- Product Registration Card
- STOP SHEET

Welcome

Getting Ready

Using the Product

Other Helpful Information

Important Information on Use

Handling the Product

- CAUTION** Do not subject the product to strong impact, as it may damage the product or destroy the recorded data.
- Do not apply unnecessary force to the product's display surface, as it may damage the display.
- Placing the product in a bag along with hard objects may damage the product in the event of contact with those objects.
- Do not spray insecticide or apply other volatile chemicals on or around the product. Also, avoid keeping a rubber or PVC product in contact with the product for a long period. The surface color may change or the exterior coating may peel off.
- Do not place the product in a trouser pocket, etc. When you sit down, the product may receive strong impact and sustain damage.
- Do not forcibly press in the Plus Touch. A strong force will be exerted on the internal parts and may damage them.

Location of Use

- NOTE** Using this product near a radio, television, cellular phone, etc., may cause radio interference. If interference should occur, move the product away from such appliances/devices.

Condensation

- CAUTION** Water droplets may form on the surface of the product after the product has been carried into a warm place directly from a cold place or when a cold room where the product is used is heated quickly. In such cases, water droplets may also be present inside the product, so do not turn on the power but wait for approximately one hour. Failure to do so may result in damage, malfunction or loss of recorded data.

Cleaning the Product

To clean the exterior, wipe it gently with a soft cloth.

- CAUTION** Never use benzine or thinner, as it may cause discoloration or damage to the finish.

- NOTE** When using a chemical cleaning cloth, follow the instructions for the cleaning cloth you're using.

Recorded Tracks

CAUTION Tracks that have been damaged or erased due to a problem in the product or PC may not be recovered.

NOTE Once transferred to and recorded in the gigabeat, tracks cannot be decrypted simply by transferring it back to a PC.
Once transferred to and recorded in the gigabeat, tracks cannot be played on another gigabeat simply by copying it to the other gigabeat.

Copyrights

- The unauthorized recording, downloading, use, distribution, or revision of copyrighted content is prohibited under the Copyright Laws of the United States and other countries, and may subject you to civil and/or criminal liability. Please be advised that you must obtain permission from the applicable copyright owners to download copyrighted content, including music files, in any format, including the MP3 and WMA formats, prior to the downloading thereof. Toshiba has no right to grant and does not grant permission to download any copyrighted content.

Music CD

- Use a disc that has the  mark on the disc label surface. When discs that fall outside of the CD standard are used, stable playback and optimum sound quality cannot be guaranteed.

Welcome

Getting Ready

Using the Product

Other Helpful Information

Important Information on Use (Continued from the previous page)

Internal Hard Disk

CAUTION

This product has a built-in hard disk. If the disk is subjected to impact, vibration or change in the environment, such as temperature change, it may result in damage to the unit, malfunction and/or data loss. When using this product, pay attention to the following instructions:

- Do not place the product under direct sunlight, in a closed car, near a heater or where the product will be subject to high temperatures.
- Do not place the product in a place where it will be subject to extremely low temperatures.
- Do not subject the product to sudden changes in temperature as condensation may occur.
- Do not use the product in a thunderstorm.
- Do not place the product near a magnet, speaker or other object generating a magnetic field.
- Do not place the product where it will be subject to strong vibrations.
- Do not place or drop an object on the product.
- Do not place the product where it will be exposed to water or high humidity.
- Do not place a cup or other container of liquid near the product since spilled liquid may enter the product.
- Do not subject the product to vibration or impact, or swing it around or drop it, regardless of whether or not the product is operating.
- Do not forcibly push, squeeze or twist the product.
- While writing to or reading from the built-in hard disc, do not turn off the power, disconnect the USB cable, nor remove the gigabeat from the USB CRADLE.

NOTE

Regularly back up the data in the internal hard disk so that it can be recovered in the event of corruption or loss. TOSHIBA shall not be liable whatsoever for loss of data stored on the internal hard disk.



AC Adapter

When using the AC adapter, carefully read and observe the information in “Safety Precautions” (➔ p. 6) as well as the following instructions.

⚠ WARNING Be sure to use the supplied AC adapter. The use of another adapter may result in damage, heat generation or fire, possibly resulting in serious injury.

Do not use the AC adapter with any equipment other than this product.

Do not allow other metal to touch the plug of the connector cable.
Short-circuiting may result.

⚠ CAUTION When connecting the adapter, firmly insert the plug of the connector cable into the AC adapter jack on the product. Inserting the plug into another terminal may result in damage.

When removing the connector cable, pull it by the plug. Do not pull directly on the cable.

Do not drop the AC adapter or otherwise subject it to strong impact.

Do not use the AC adapter in a hot, humid place.

Do not use the AC adapter on an object that is easily affected by temperature increases. Heat marks may remain where the AC adapter has been placed.

NOTE The AC adapter is designed for indoor use only.

The surface temperature of the AC adapter may increase while the power is on, but this does not mean the adapter is faulty. Before carrying, unplug the AC cable and wait until the AC adapter cools.

Buzzing noises may occasionally be heard from the inside of the AC adapter, but this is not abnormal.

Using the AC adapter near a radio, television or cellular phone may cause radio interference, so use the adapter at a sufficient distance from such appliances/devices.

Specifications

AC adapter (ADP-15HH)

Power source:	100 to 240 VAC, 50/60 Hz
Rated input capacity:	100 to 240 VAC, 31 to 50 VA
Rated output:	5 VDC, 3 A
Operating temperature:	0 to +40°C
Storage temperature:	-20 to +65°C
Maximum external dimensions:	50 mm x 28 mm x 65 mm (width x height x depth)
Weight:	Approx. 200 g
Length of connector cable:	Approx. 1.5 m

NOTE The supplied AC cable is designed for use in the particular region. When using the product overseas, provide a separate AC cable conforming to the local standard.

Key Product features

- **Photo Viewer**-Download your favorite images to gigabeat and view slideshows. Download album covers and search via album cover.
- **Plus Touch sensor control** - lets you scroll through your music collection and photos quickly and easily.
- **Use the supplied gigabeat room, Windows Media Player or Napster To Go software to manage your music and photos.** ****
- **Supports MP3, WMA and WAV music formats.**
- **Transfer an entire CD to your gigabeat at the push of one button in as little as 5 minutes*.**
- **Rechargeable Lithium Ion battery for up to 16 hours** of playback.**
- **Built in 10, 20, 40 and 60GB hard drives offer up to 2500, 5000, 10000 and 15000 songs*** respectively.**

* This number is based on a 60-minute CD being transferred using a desktop PC with a 3.4 GHz Pentium 4 processor and 512MBytes of RAM. Transfer time depends on the total length of the CD to be transferred with the RipRec function and the PC's performance.

** Battery life and number of charge cycles will vary depending on use and settings. Rechargeable battery has a limited service life and may eventually need to be replaced. The continuous playback time will vary depending on the operating condition, environment, the number of times the built-in battery has been recharged, etc.

*** These values are for reference purposes only and may vary.

****The gigabeat room software must be used to download photos.

Welcome

Getting Ready

Using the Product

Other Helpful Information

Product Overview

The gigabeat is a portable, hard disk drive (HDD) audio player.

The tracks that will be played back are transferred to the gigabeat from the personal computer (PC) using the supplied "gigabeat room" software, Windows Media Player 10 or Napster.

■ Transfer Using gigabeat room

See Owner's Manual-"gigabeat room" for details about the gigabeat room.

The RipRec function (which transfers the data of a music CD to the gigabeat with the touch of a button) can be used.

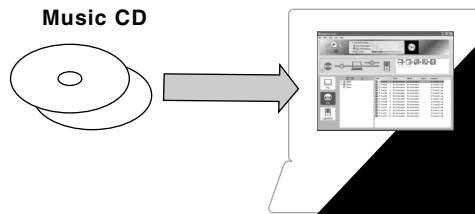

■ Transfer Using Windows Media Player 10

See "When Using Windows Media Player 10" (Owner's Manual-"gigabeat room" p. 17) when using Windows Media Player 10 or Napster.

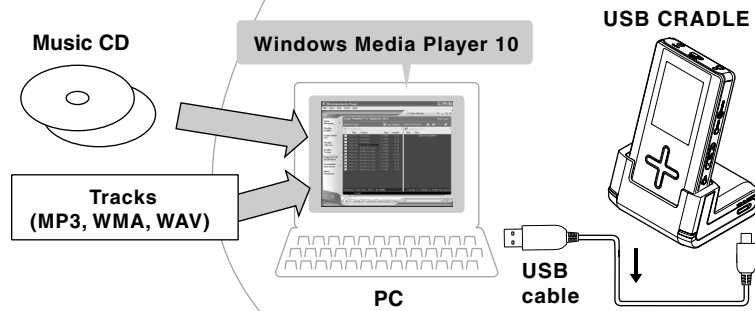

Welcome

Getting Ready

Using the Product

Other Helpful Information

■ **Transfer Using Napster**

See “When using Napster” (➡ Owner’s Manual-“gigabeat room” p.46)

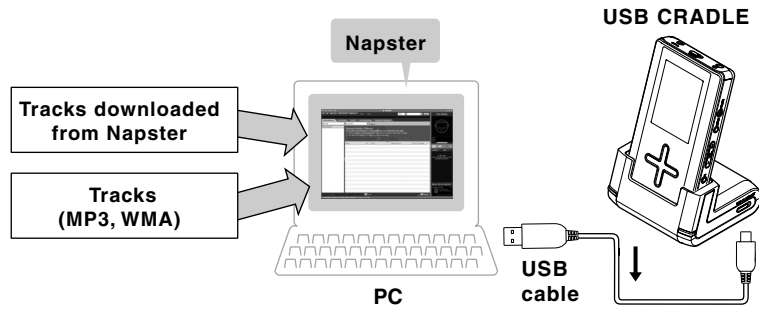

	When using gigabeat room	When using Windows Media Player 10	When using Napster
Transferring of protected WMA files	No	Yes	Yes
Transferring of non-protected WMA files	Yes	Yes	Yes
Transferring of image files	Yes	No	No
Album cover photograph settings	Yes	No	No
Functions of RipRec button and Sync button on the USB CRADLE	Yes	No	No
USB connection	USB 2.0	USB 1.1	USB 1.1

Yes: Available
No: Not available

Convert the music CD to WMA tracks on your PC beforehand, using Windows Media Player 10 or Napster.

NOTE The gigabeat cannot play tracks other than that which is transferred by using gigabeat room or Windows Media Player 10 or Napster.

Track transferred to the gigabeat by using gigabeat room or Windows Media Player 10 or Napster has been encrypted and therefore cannot be played on any other gigabeat or media player.

Tracks copied to other gigabeat cannot be played.

Operation cannot be guaranteed when the gigabeat has been connected to a PC using a USB hub.

Welcome

Getting Ready

Using the Product

Other Helpful Information

Product Overview (Continued from the previous page)

Transfer the tracks to the gigabeat before using the gigabeat.

Welcome

Getting Ready

Using the Product

Other Helpful Information

**Prepare the gigabeat:
Charging the Built-in Battery.**

⇒ p.30

**Prepare the PC:
Install the supplied software.**

⇒ Owner's Manual-"gigabeat room", p.9

Using gigabeat room

**Using Windows Media
Player 10**

**Insert a music CD into
the CD-ROM drive of the PC.**

**Prepare the tracks:
Convert a music CD to tracks
using Windows Media Player
10.**

See Windows Media Player 10
"Help" for details about the
method.

**Connect the PC and
the gigabeat.**

⇒ Owner's Manual-
"gigabeat room", p.14

**Connect the PC and
the gigabeat.**

⇒ Owner's Manual-
"gigabeat room", p.14

**Transfer of tracks:
Transfer tracks of the music
CD to the gigabeat using
gigabeat room.**

⇒ Owner's Manual-
"gigabeat room", p.22

**Transfer of tracks:
Transfer tracks to the
gigabeat using Windows
Media Player 10.**

⇒ Owner's Manual-
"gigabeat room", p.44

Play the tracks on the gigabeat.

⇒ p.34

Tracks can also be transferred to the gigabeat using Napster.

■ **About the gigabeat room**

The gigabeat room is software that encrypts the tracks of a music CD or tracks in the form of an MP3, WMA, or WAV file to the WMA format, and transfers it to the gigabeat player. See Owner's Manual-"gigabeat room" for details about the gigabeat room.

Welcome

Getting Ready

Using the Product

Other Helpful Information

Names and Functions of the Parts

■ Front/Side View

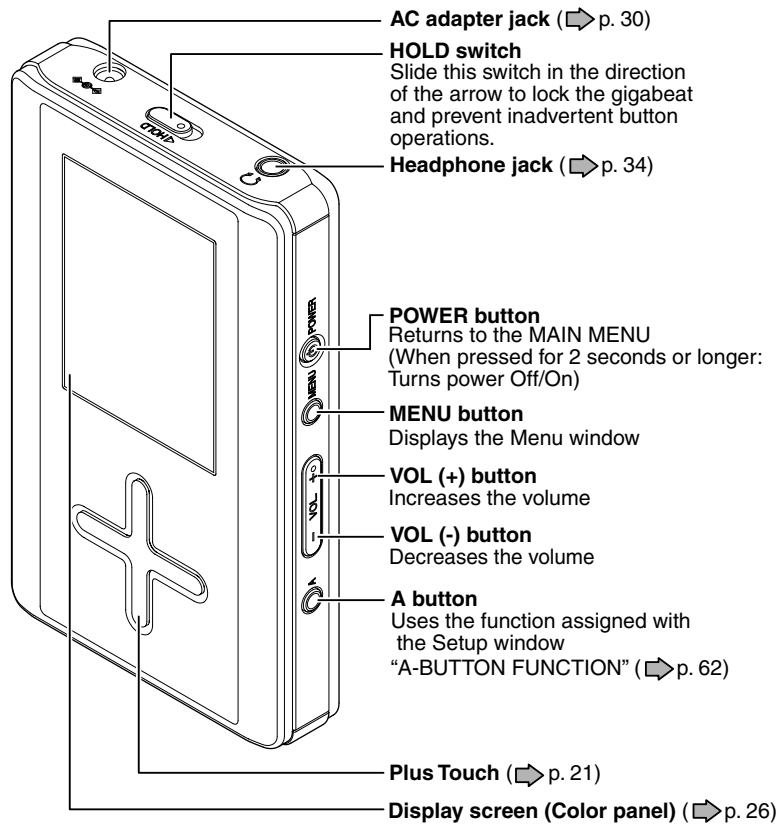

Welcome

Getting Ready

Using the Product

Other Helpful Information

■ Plus Touch Operation

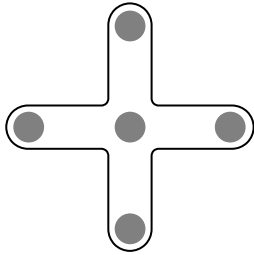

Touch : Tap

Hold : Press and Hold

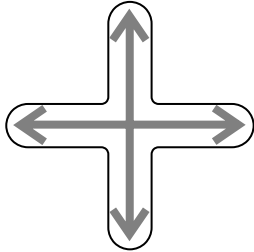

Scroll : Slide your finger across the Plus Touch in the desired direction

Welcome

Getting Ready

Using the Product

Other Helpful Information

Names and Functions of Parts (Continued from the previous page)

■ Rear View

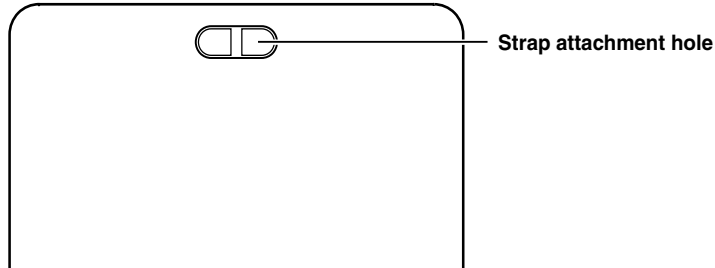

■ Bottom View

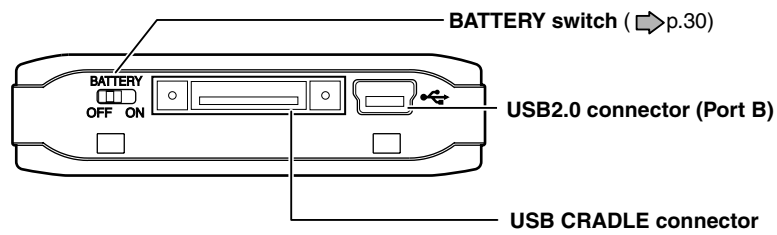

The bodies of the MEGF60 and MEGF40 are slightly thicker than those of the MEGF20 and MEGF10, but in this manual all descriptions use illustrations of the MEGF20 and MEGF10.

CAUTION Connect only supplied accessories and genuine options to the USB CRADLE connector at the bottom of the unit.

■ **Wired remote control (Supplied with the MEGF60 and MEGF40 and available as an option with the MEGF20 and MEGF10)**

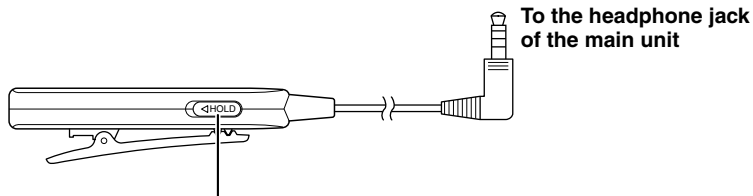
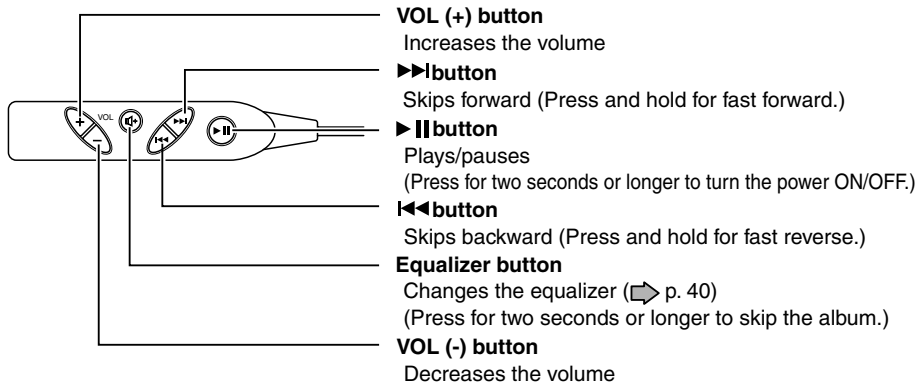

HOLD switch
Slide this switch in the direction of the arrow to lock the gigabeat against inadvertent button operations of the wired remote control.
Note that the operations of the main unit will continue to function as long as the main unit is not in the HOLD condition.

Welcome

Getting Ready

Using the Product

Other Helpful Information

Names and Functions of Parts (Continued from the previous page)

■ USB CRADLE

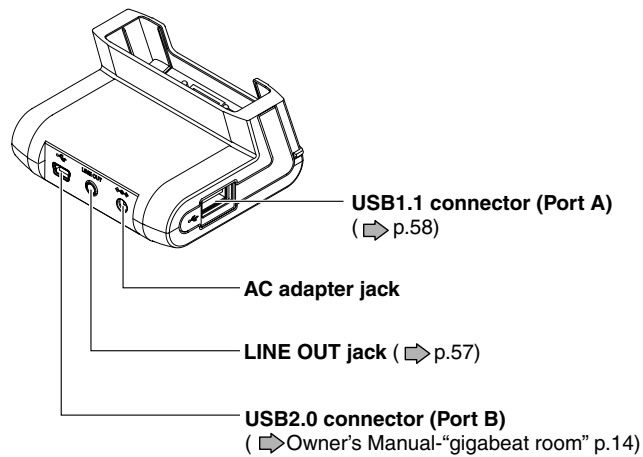
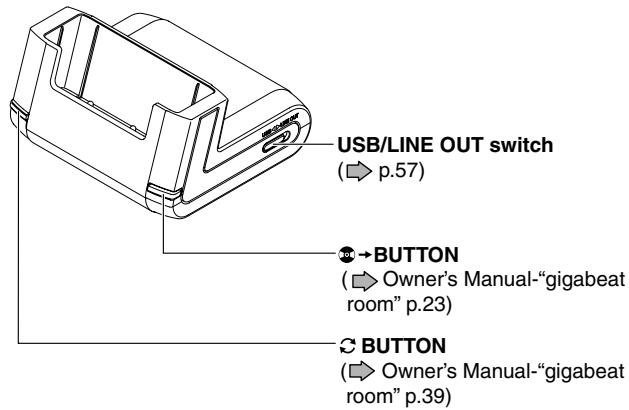

Welcome

Getting Ready

Using the Product

Other Helpful Information

● How to Connect the gigabeat and the USB CRADLE

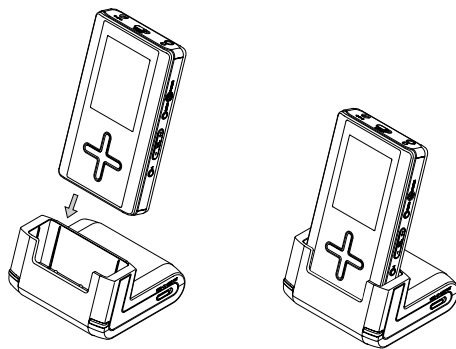

Insert and press down gently.

Welcome

Getting Ready

Using the Product

Other Helpful Information

Display Windows

■ MAIN MENU

This window is displayed when the power is turned on. A press of the POWER button while another window is displayed will also result in a display of the MAIN MENU.

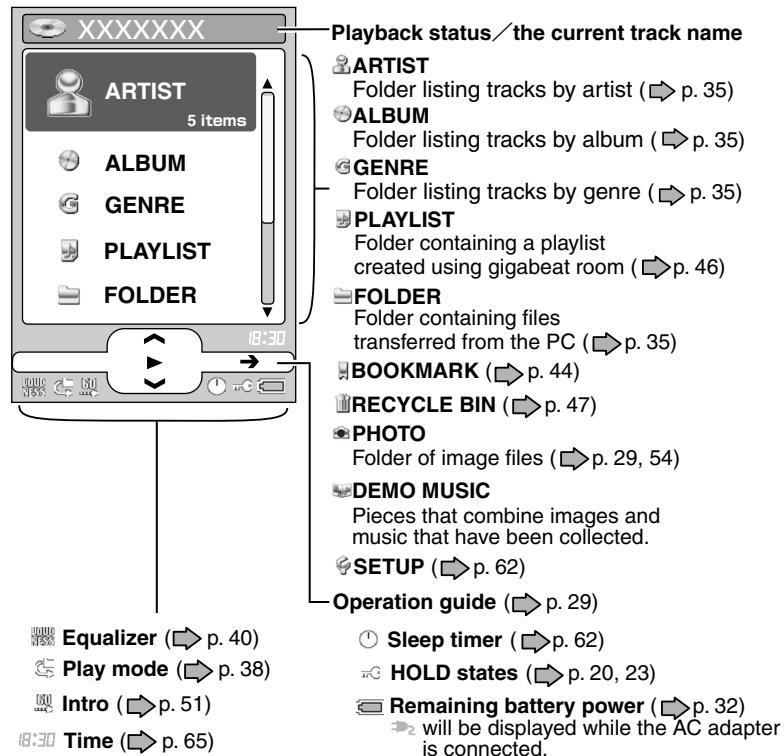

NOTE The various display windows can be customized. See "Changing Screen Themes". (p. 52)

■ Artist in MAIN MENU/Album/Genre Structure

The tracks that were transferred to the gigabeat enter the **FOLDER** inside the gigabeat. The desired tracks can be selected in **ARTIST**, **ALBUM**, and **GENRE**.

- Actually, even with tracks having the same artist name, album name, or genre name, should there be a differing portion in the track information, it will be handled as a different track.

Welcome

Getting Ready

Using the Product

Other Helpful Information

■ Browse window

In the MAIN MENU, items except for settings are selected such as artist, album, and genre, and touching the right of the Plus Touch will display the Browse window. Details of the selected item will be displayed.

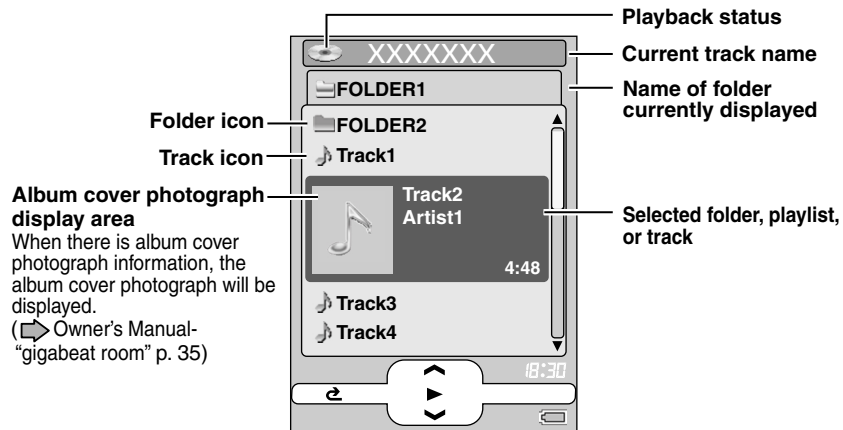

■ Play window

Information regarding the current track is displayed.

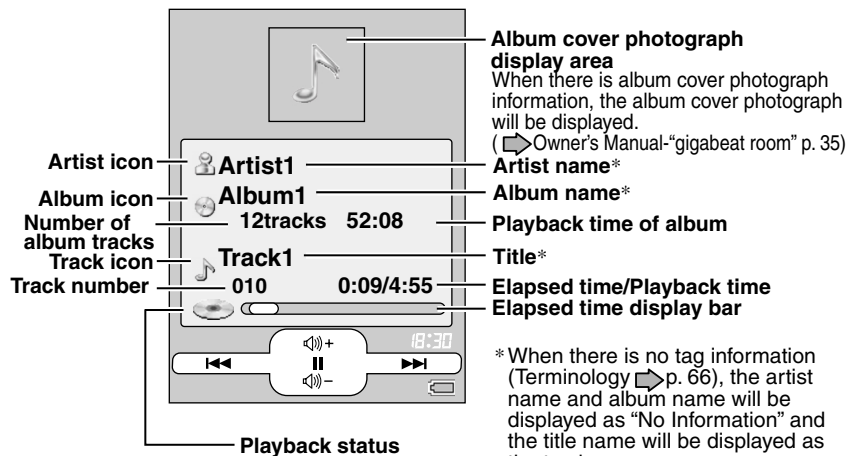

NOTE

The MAIN MENU, Browse and Setup windows will switch to the Play window if no operation is performed for approximately 60 seconds.

When **NORMAL3** is selected in the **SCREEN THEME** (➡ p. 52), "playback time" will not be displayed.

Welcome

Getting Ready

Using the Product

Other Helpful Information

Display Windows (Continued from the previous page)

■ Setup window

Selecting **SETUP** in the MAIN MENU and touching the right of the Plus Touch will display the Setup window. You can change or confirm settings in this window. (➡ p. 62)

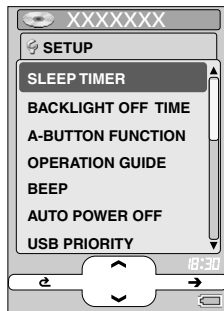

■ Menu window

Pressing the MENU button will display the Menu window on the screen.



- Pressing the MENU button again will close the Menu window. If no operation is performed, the Menu window will close in approximately 10 seconds.
- Touching the left of the Plus Touch at the uppermost window of the Menu window will also cause the Menu window to go off.

Welcome

Getting Ready

Using the Product

Other Helpful Information

■ Photo Viewer window

Selecting **PHOTO** in the MAIN MENU and touching the right of the Plus Touch will display the Photo Viewer window.

When the Photo Viewer window is set, the screen display will appear in the horizontally (wide screen).

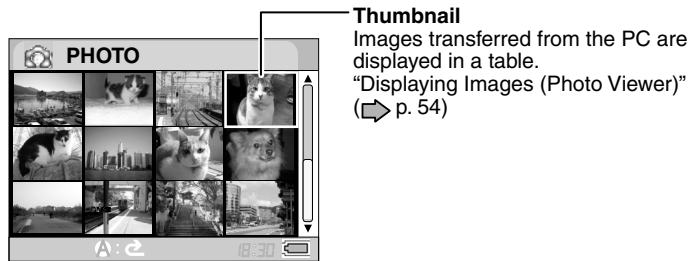

■ Operation Guide

The operation guide displays the operation when the Plus Touch has been touched.

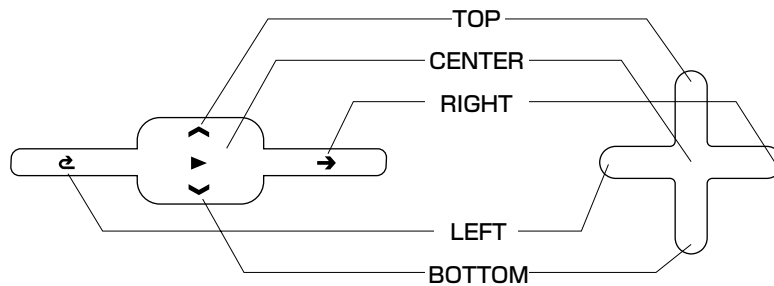

- The operation guide can be hidden by setting **OPERATION GUIDE** to **OFF** at the Menu window, or by setting **OPERATION GUIDE** (➡ p. 62) to **OFF** in the Setup window.
- When the screen is displayed horizontally, pressing button A will turn off the operation guide and another press of button A will display the operation guide.

Welcome

Getting Ready

Using the Product

Other Helpful Information

Charging the Built-in Battery

NOTE When the AC adapter is connected to the gigabeat, charging starts automatically. If you are using the gigabeat for the first time after purchase, or when the gigabeat hasn't been used for a prolonged period, fully charge the battery beforehand. One charging method is to connect the AC adapter directly to the gigabeat, another method is to use the USB CRADLE. Note that a USB connection with the PC will also permit charging.

● Preparation

Set the BATTERY switch on the bottom of the main unit to **ON**.

This switch prevents over-discharge of the built-in battery after shipment.

Set the BATTERY switch to **ON** the first time the gigabeat is used after purchasing it.

If you will not be using the gigabeat for a prolonged period, set the BATTERY switch to **OFF**.

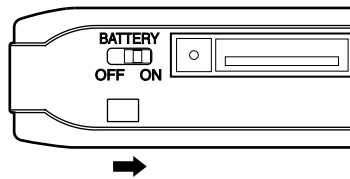

NOTE Setting the BATTERY switch to **OFF** will return all of the settings to their default values (which is the condition when the gigabeat was first used after purchasing it).

Direct Charging from the AC Adapter

Connect the AC adapter to the gigabeat in the order indicated in the diagram below.

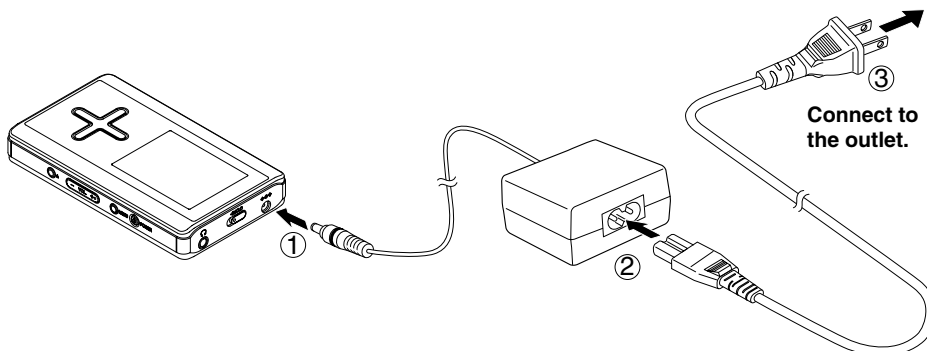

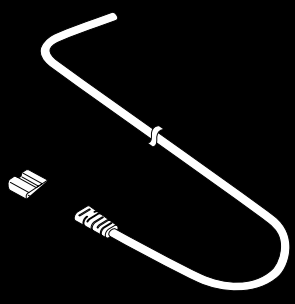

Charging the Built-in Battery (Continued from the previous page)



Welcome

Getting Ready

Using the Product

Other Helpful Information

NOTE

When charging of the gigabeat has started, the charging icon  (orange) is displayed on the display screen. When charging is completed, the charging completion icon  (green) is displayed on the display screen. If the screen does not function in this way, see “Troubleshooting” (➔ p. 68).





The charging icon is not displayed when charging with a USB connection.

Pressing the POWER button during USB charging might not turn on the power when the gigabeat has not been used for a long time or when the battery is too weak to supply power. Cancel the USB connection, connect the AC adapter, and then turn on the power.

The charge time will vary depending on the condition of the built-in battery, ambient temperature, etc.

The charge may stop temporarily to limit the temperature increase in the gigabeat.

Charge the built-in battery within the specified operating-temperature range. If the temperature is outside the specified range, the gigabeat may not be charged. (➔ p. 69)

As the remaining battery power drops, the indication (➔ p. 26) will change in the following sequence: ( →  →  → ). Recharge the gigabeat when the remaining battery power becomes low.

 will be displayed while the AC adapter is connected.

Turning the Power ON/OFF

● Preparation

- Set the BATTERY switch to **ON**. (➡ p. 30)

Turning the Power ON/OFF

Press and hold the POWER button.



Holding down the ►|| button of the wired remote control (supplied with the MEGF60, MEGF40) for 2 seconds or longer will also turn the power on or off.

NOTE

The power cannot be turned on or off during the HOLD condition. Switch off HOLD and then press the POWER button.

When the gigabeat is used for the first time or when turning on the power for the first time after resetting (➡ p.68) or after the battery became exhausted and was subsequently charged, a **TIMEZONE** Setup window will be displayed. Set the **TIMEZONE** (➡ p.64) and **DATE/TIME** (➡ p.65).

When not playing music and not in use of the screen and power will turn off automatically. While connected to the AC adapter, the screen will darken, but it will not go off.

See “BACKLIGHT OFF TIME” (➡ p. 62).

See “AUTO POWER OFF” (➡ p. 62).

When the screen is off, the press of a button on the side of the gigabeat will light the screen and the gigabeat will receive the input of that button.

When the screen is off, operation of the Plus Touch will light the screen, but that input will not be received by the gigabeat.

Welcome

Getting Ready

Using the Product

Other Helpful Information

Playing Music Tracks

● Preparation

- Transfer tracks to the gigabeat beforehand. See the Owner's Manual—"gigabeat room" for the procedure for transferring tracks.
- Connect the supplied EARBUDS to the headphone jack on the main unit.
- When using the wired remote control (supplied with the MEGF60 and MEGF40, optional for MEGF20/MEGF10), connect the wired remote control to the headphone jack on the main unit, and connect the supplied EARBUDS to the wired remote control.
- Turn the power **ON**. (➡ p. 33)

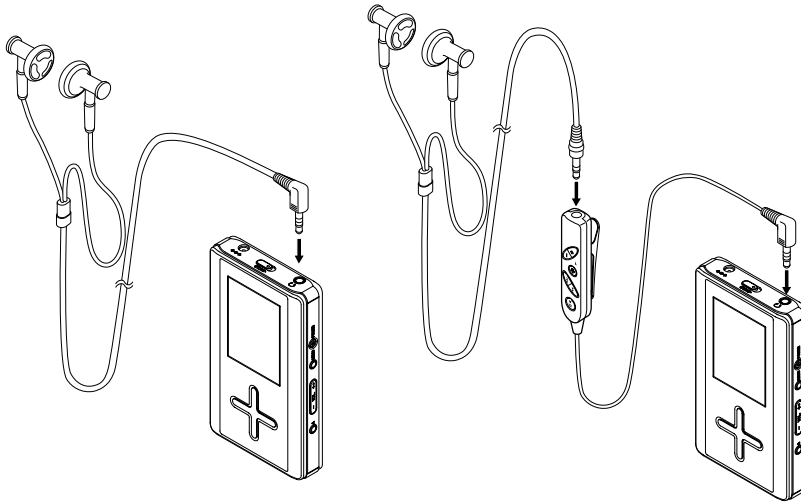

NOTE

Turn the power to the gigabeat **OFF** before connecting or disconnecting the wired remote control.

Insert the plug of the wired remote control firmly to the end. Incomplete insertion may disable the remote controller operation, although sound may be heard.

When connecting any equipment other than EARBUDS, do so via the supplied wired remote control. Connecting other equipment directly to the headphone jack may cause a malfunction.

Playing the Track Selected

- 1 In the **MAIN MENU**, touch the top or bottom of the Plus Touch and select a folder (from among **ARTIST**, **ALBUM**, **GENRE**, **FOLDER**), then touch the right of the Plus Touch.



The Browse window (the content of the selected folder) will be displayed.



- 2 Touch the top or bottom of the Plus Touch and select the folder or the track that you want to play back.



Once the folder has been selected, touching the right of the Plus Touch permits the display of the folders or tracks within that folder. Touching the left of the Plus Touch will cause a return to the display of the content of the folder one level higher.



- 3 Touch the center of the Plus Touch.

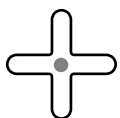

This will play back the selected folder or track according to **PLAY MODE** (➡ p. 38).

Performing the operations of Steps 1 through 3 during playback will discontinue the playback and start playback of the selected folder or track.



NOTE

To change the track order, press the **MENU** button, then select and execute **SORT** of the displayed Menu window or **SORT** of the Setup window.

To display an enlarged cover photograph, select the track, then press the **MENU** button and select **DISPLAY JACKET** on the displayed Menu window.

To display the album cover photograph as thumbnails, select the album, press the **MENU** button and select **SHOW THUMBNAIL** on the displayed Menu window.

WMA data that is copyright protected in Windows Media DRM10 might display the errors described below and not be playable.

- (1) "PLAY LIMIT EXCEEDED" (The play limit during which playback is possible has been exceeded and playback is not possible.)
- (2) "SYNCHRONIZE WITH THE PC" (The message is displayed when the gigabeat hasn't been connected to the PC for a prolonged period or after a reset. In this circumstance, a USB connection is made with the PC and playback becomes possible upon synchronization with Windows Media Player 10.)

Welcome

Getting Ready

Using the Product

Other Helpful Information

Playing Music Tracks (Continued from the previous page)

Stopping Playback

Touch the center of the Plus Touch during playback.

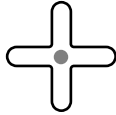

Touching the center of the Plus Touch one more time will continue playback.

Controlling the Volume

Press the VOL (+) or VOL (-) button.

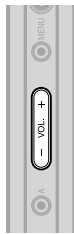

Pressing the VOL (+) button will increase the volume.
Pressing the VOL (-) button will decrease the volume.
Pressing the button will display the volume control bar. The bar will disappear in approximately two seconds after releasing the button.

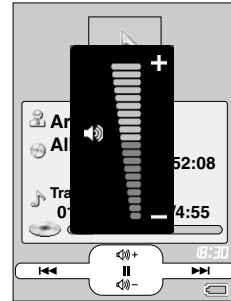

The volume can also be adjusted by touching the top or bottom of the Plus Touch.

Touching the top raises the volume.

Touching the bottom lowers the volume.

The **PLUS TOUCH** ↑↓ at the Setup window (➡ p. 62) can be used to toggle between **VOLUME** and **ALBUM SKIP**.

NOTE

When the folder to be played back contains a number of files, or after playback has been stopped, it may take several seconds from the time the center of the Plus Touch is touched until playback begins.

On rare occasions noise may be heard, depending on the track.

Assigning **MUTE** to button A of the gigabeat (➡ p. 62) and pressing button A will mute the audio. While in mute, pressing the button A again will cancel the mute function.

Setting **PRESET VOLUME** at the Setup window (➡ p. 62) to **ON** permits playback at the volume that was set with Music information edit of the gigabeat room.

Editing Tag Information (➡ Owner's Manual-"gigabeat room" p. 34)

When the gigabeat is connected to the AC adapter via the USB CRADLE, the setting of the **PRESET VOLUME** has no effect.

Fast Forward/Reverse

Hold the left or right of the Plus Touch while the Play window is displayed during playback.

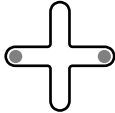

Left : Fast reverse
Right : Fast forward

When the end or beginning of a given track is reached, the gigabeat will move to the next or previous track.
Releasing the Plus touch will return the Playback mode.

NOTE If the play mode (➡ p. 38) is set to Repeat One Song, holding the Plus Touch will not move to the next/previous track.
No sound will be played during fast reverse/forward.

Skip Forward or Back

Touch the left or right of the Plus Touch while the Play window is displayed during playback or during pause.

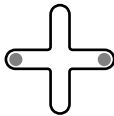

Left : Skips to the beginning of the current track.
When at the beginning of the track, skips to the beginning of the previous track.
Right : Skips to the beginning of the next track.

NOTE Holding the left or right of the Plus Touch during pause will continue the skip until you stop holding the Plus Touch.

Skip to the Next Album

Press the MENU button during the display of the Play window to display the Menu window, touch the top or bottom of the Plus Touch and select “ALBUM SKIP”.

NOTE You can also skip to the next album by pressing the equalizer button on the wired remote control for two seconds or longer.
Setting the **PLUS TOUCH** ↑↓ at the Setup window (➡ p. 62) to **ALBUM SKIP** permits a skip to be made to the previous or the next album by touching the top or bottom of the Plus Touch.

Welcome

Getting Ready

Using the Product

Other Helpful Information

Setting the Play Mode

You can select a desired play mode, such as "REPEAT" or "RANDOM".

- 1 Press the MENU button in the Play window.**



The Menu window appears.



- 2 Touch the top or bottom of the Plus Touch and select "PLAY MODE", then touch the right of the Plus Touch.**



A list of play modes will be displayed.



- 3 Touch the top or bottom of the Plus Touch and select the play mode that you would like to set, then touch the right of the Plus Touch.**

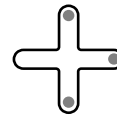

The mode will be set and there will be a return to the Play window. When playback is in progress the response is immediate, and during the pause condition touching the right of the Plus Touch will start playback in the play mode that was set.



Setting the Equalizer Mode

You can select a desired equalizer mode. (Terminology ➔ p.66)

- 1 Press the **MENU** button in the Play window.



The Menu window appears.



- 2 Touch the top or bottom of the Plus Touch and select the “**EQUALIZER/SRS WOW**”, then touch the right of the Plus Touch.

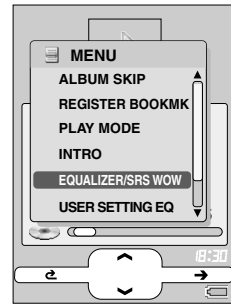

- 3 Touch the top or bottom of the Plus Touch and select the type of equalizer that you would like to set, then touch the right of the Plus Touch.



The equalizer mode is set and the screen returns to the Play window.

Selecting **USER** will result in playback at the sound quality that was set with **USER SETTING EQ**. See “Adjustments When ‘USER’ Has Been Selected” (➔ p.42).



Display in the Play window	Equalizer mode	Display in the Play window	Equalizer mode
None	FLAT	LATIN 1	LATIN 1
BASS +	BASS+	LATIN 2	LATIN 2
BASS ++	BASS++	PIANO 1	PIANO 1
LOUDNESS	LOUDNESS	PIANO 2	PIANO 2
ACOUSTIC 1	ACOUSTIC 1	POPS 1	POPS 1
ACOUSTIC 2	ACOUSTIC 2	POPS 2	POPS 2
CLASSIC 1	CLASSIC 1	R&B 1	R&B 1
CLASSIC 2	CLASSIC 2	R&B 2	R&B 2
DANCE 1	DANCE 1	ROCK 1	ROCK 1
DANCE 2	DANCE 2	ROCK 2	ROCK 2
HARD 1	HARD 1	VOCAL 1	VOCAL 1
HARD 2	HARD 2	VOCAL 2	VOCAL 2
HIP HOP 1	HIP HOP 1	USER	USER
HIP HOP 2	HIP HOP 2	SRS WOW1*	SRS WOW1*
JAZZ 1	JAZZ 1	SRS WOW2*	SRS WOW2*
JAZZ 2	JAZZ 2	SRS WOW3*	SRS WOW3*

* The SRS WOW function (which offers a natural, three-dimensional sound stage, rich bass, and a distinctly delineated clear sound) is activated. There are 3 types of function modes.

NOTE

Touching the top or bottom of Plus Touch temporarily sets the sound quality setting of the selected equalizer. Note that the setting will not be finalized unless the center of the Plus Touch is touched.

The equalizer mode can also be selected by pressing the equalizer button (EQ+) on the wired remote control.

You can also set the equalizer mode in the Setup window. (➡ p. 62)

Setting **PRESET EQ** at the Setup window (➡ p. 62) to **ON** permits playback at the equalization that was set with Music information edit of the gigabeat room.

Editing Tag Information (➡ Owner's Manual-"gigabeat room" p. 34)

The equalization that was set with the gigabeat room Edit Track Information is not reflected in the equalizer icon on the screen. The equalization that was set can be checked with **PROPERTIES** (➡ p. 50) on the Menu window that is displayed by pressing the MENU button.

When the gigabeat is connected to the AC adapter via the USB CRADLE, the equalizer is set to **FLAT** in spite of its setting and display and the **PRESET EQ** has no effect.

Welcome

Getting Ready

Using the Product

Other Helpful Information

Setting the Equalizer Mode (Continued from the previous page)

Adjustments When "USER" Has Been Selected

- 1** In the MAIN MENU, touch the top or the bottom of the Plus Touch and select "SETUP", then touch the right of the Plus Touch.

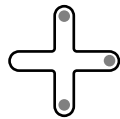

The Setup window appears.



- 2** Touch the top or the bottom of the Plus Touch and select "USER SETTING EQ", then touch the right of the Plus Touch.



The adjustment window of the User Setting Equalizer will be displayed.

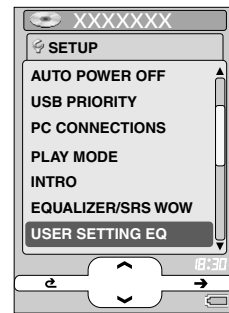

- 3** Touch the right or left of the Plus Touch and select "TREBLE" or "BASS".



Right : Treble
Left : Bass

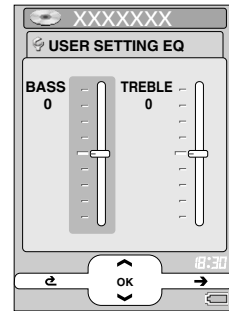

4 Touch the top or bottom of the Plus
Touch to adjust.

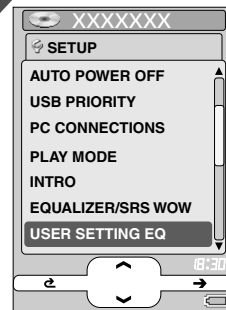
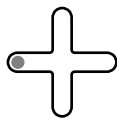
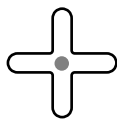
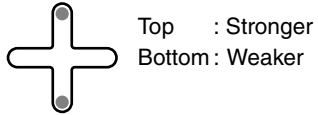

Ready

Using the Product

Other Helpful Information

oo a i g

By bookmarking your favorite tracks, you can play only the bookmarked tracks.

1 Press the **oo** button on the remote control to bookmark the selected track.

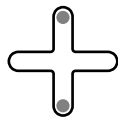

2 Press the **+** button on the remote control. The Menu window appears.



3 Press the **oo** button on the remote control to bookmark the selected track.

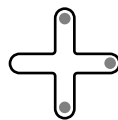

The selected track is bookmarked and a bookmark icon will be displayed beside the name.

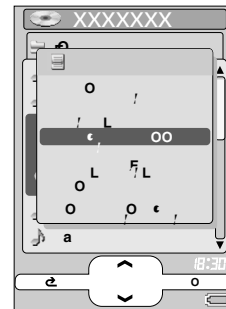

NOTE You can also select **oo** by pressing the MENU button in the Play window.
 To cancel bookmark, select the bookmarked tracks and select **oo** in step 3.
 You can bookmark up to 50 audio files.
 Playlists and folders cannot be bookmarked.
 The **oo** function can be assigned to "A button". See "A-BUTTON FUNCTION" (➔ p. 62).

/a i g a /a /i t

Using the gigabeat room to create a playlist on the gigabeat will permit playback of the playlist from the contents of the

Creating a Playlist (➡ Owner's Manual-"gigabeat room" p. 27)

1 o u h t h o p o o t o f t h / u o u h a / t a / u l o b h . , t h o u h t h i g h b f t h



The contents of the L U will be displayed.



2 o u h t h o p o o t o f t h / u o u h a / t t h p / a / i t t h a t o u a t o p / a a .



A further touch to the right of the Plus Touch will also permit selection of the tracks in that playlist.



3 o u h t h t o f t h / u o u h .



This will play back the selected playlist or track according to L O (➡ p. 38).

Performing the operations of Steps 1 through 3 during playback will discontinue the playback and start playback of the selected playlist or track.



/o

e tti g a

i g t h o u t

o t h / d u / b a t h

o v i g a o t h / i (o t i v f o t h p v o v p a g)

i i g a i t h / i

- 1 t h o t o f t h / u o u h a t o f t h / u o u h . , o u h t h o p o t t h o u h t h i g h t

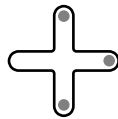

The track, etc., in the recycle bin will be displayed.
The track data that was placed in the recycle bin cannot be played back.

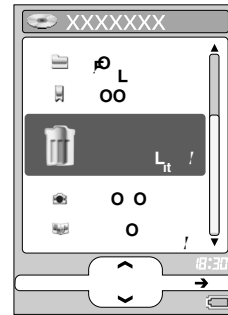

NOTE

To restore tracks, etc., from the recycle bin, select a desired file in the Recycle Bin window, press the MENU button to display the Menu window, and select . If the gigabeat was reset (➡ p. 68) or has shut down due to a dead battery, the recycle bin contents effective in the last session will be restored the next time the gigabeat is started.

/ t i g a i t h / i

You can completely remove tracks or playlists in the recycle bin from the gigabeat. To delete the contents of recycle bin, connect the AC adapter to the gigabeat beforehand. (➡ p. 30)

- 1 t h o t o f t h / u o u h a t o f t h / u o u h . , o u h t h o p o t t h o u h t h i g h t o f t h / u o u h .

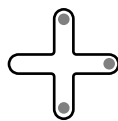

The tracks, etc., in the recycle bin will be displayed.

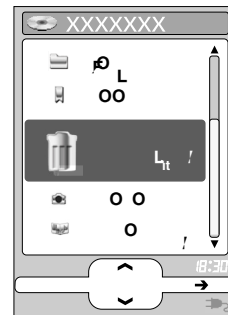

- 2 t h u t o .

The Menu window appears.

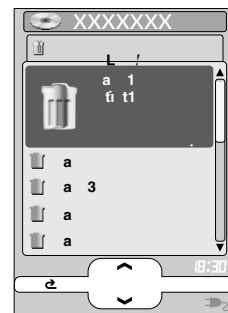

3 o u h t h o p o t o of t h / u
 o u h a / t
 t h o u h t h i g h t f t h / u L L'
 o u h .

The deletion confirmation window appears.

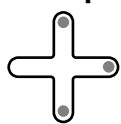
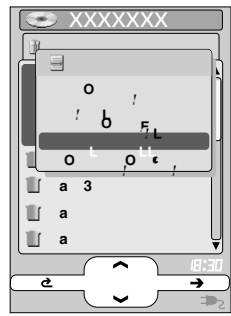
4 o u h t h o p o t o of t h / u
 o u h a / t , t h o u h
 t h i g h t f t h / u o u h .

The data in the recycle bin will be deleted from the Recycle Bin folder and also from the original folders.

Viewing Track Information

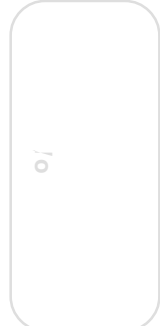
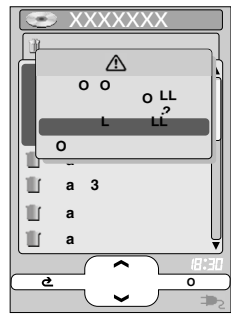
You can view the information of any track, playlist or folder.

- 1 Touch the top or bottom of the Plus Touch in the Browse window and select the track information that you would like to view.

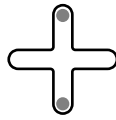

- 2 Press the MENU button.



The Menu window appears.

- 3 Touch the top or bottom of the Plus Touch and select "PROPERTIES", then touch the right of the Plus Touch.

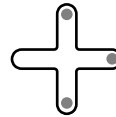

The information of the selected track, etc., will be displayed.

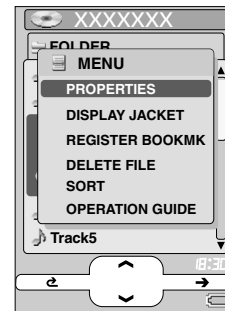

- Information displayed for a track:
 - Track name
 - File format
 - Bit rate
 - Sampling frequency
 - Playback time
 - Artist name
 - Album name
 - Genre
 - Preset volume
 - Preset equalizer
- Information displayed for a playlist:
 - Number of files registered in the playlist
 - Playback time
- Information displayed for a folder:
 - Number of folders and audio files

NOTE You can also select **PROPERTIES** by pressing the MENU button in the Play window.

Playing Intro

You can play the beginning of each track for 10 seconds or one minute.

- 1 Press the MENU button in the Play window.**



The Menu window appears.



- 2 Touch the top or bottom of the Plus Touch and select "INTRO", then touch the right of the Plus Touch.**

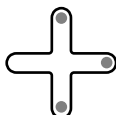

- 3 Touch the top or bottom of the Plus Touch and select the desired intro mode, then touch the right of the Plus Touch.**

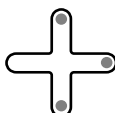

The intro mode is set and the window returns to the Play window.

Intro playback in the selected mode will start immediately if the gigabeat is currently playing, or after touching the right of the Plus Touch if the gigabeat is paused.



Display in the Play window	Intro mode	Operation
None	NONE	Plays the entire track without playing an intro.
	10 SEC. INTRO	Plays each track 10 seconds from the beginning according to the selected play mode.
	60 SEC. INTRO	Plays each track one minute from the beginning according to the selected play mode.

NOTE You can also set the intro mode in the Setup window. (➡ p. 62)

Welcome

Getting Ready

Using the Product

Other Helpful information

Changing Screen Themes

The design of the screen, the orientation of the screen display, the size of the display characters, and the size of the cover photograph display area can be changed.

- 1 Press the MENU button in the Play window.



The Menu window appears.



- 2 Touch the top or bottom of the Plus Touch and select "SCREEN THEME", then touch the right of the Plus Touch.

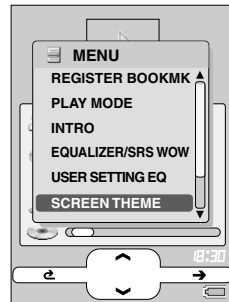
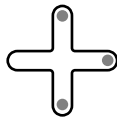

- 3 Touch the top or bottom of the Plus Touch and select the desired screen theme, then touch the right of the Plus Touch.





















The screen theme is set and there is a return to the Play window.



NOTE Screen themes can also be changed from the Setup window. (➡ p. 62)
The background can be changed from the Setup window. (➡ p. 62)

Screen themes

	Orientation of the screen display	Size of the display characters	Size of the cover photograph in the Play window		Orientation of the screen display	Size of the display characters	Size of the cover photograph in the Play window
BALL		ABC		NORMAL3		AB	
SPEAKER		ABC		NORMAL4		ABC	
SPECTRUM ANALYZER		ABC	NONE	NORMAL5		AB	
NORMAL1		ABC		NORMAL6		ABC	
NORMAL2		ABC		NORMAL7		AB	

Welcome

Getting Ready

Using the Product

Other Helpful Information

Displaying Images (Photo Viewer)

Using the gigabeat room, images transferred from the PC can be shown in a thumbnail display, full-screen display, or slideshow.

1

In the MAIN MENU, touch the top or bottom of the Plus Touch and select "PHOTO", then touch the right of the Plus Touch.



The image display will be in the horizontal orientation and images transferred from the PC will be displayed as thumbnails.



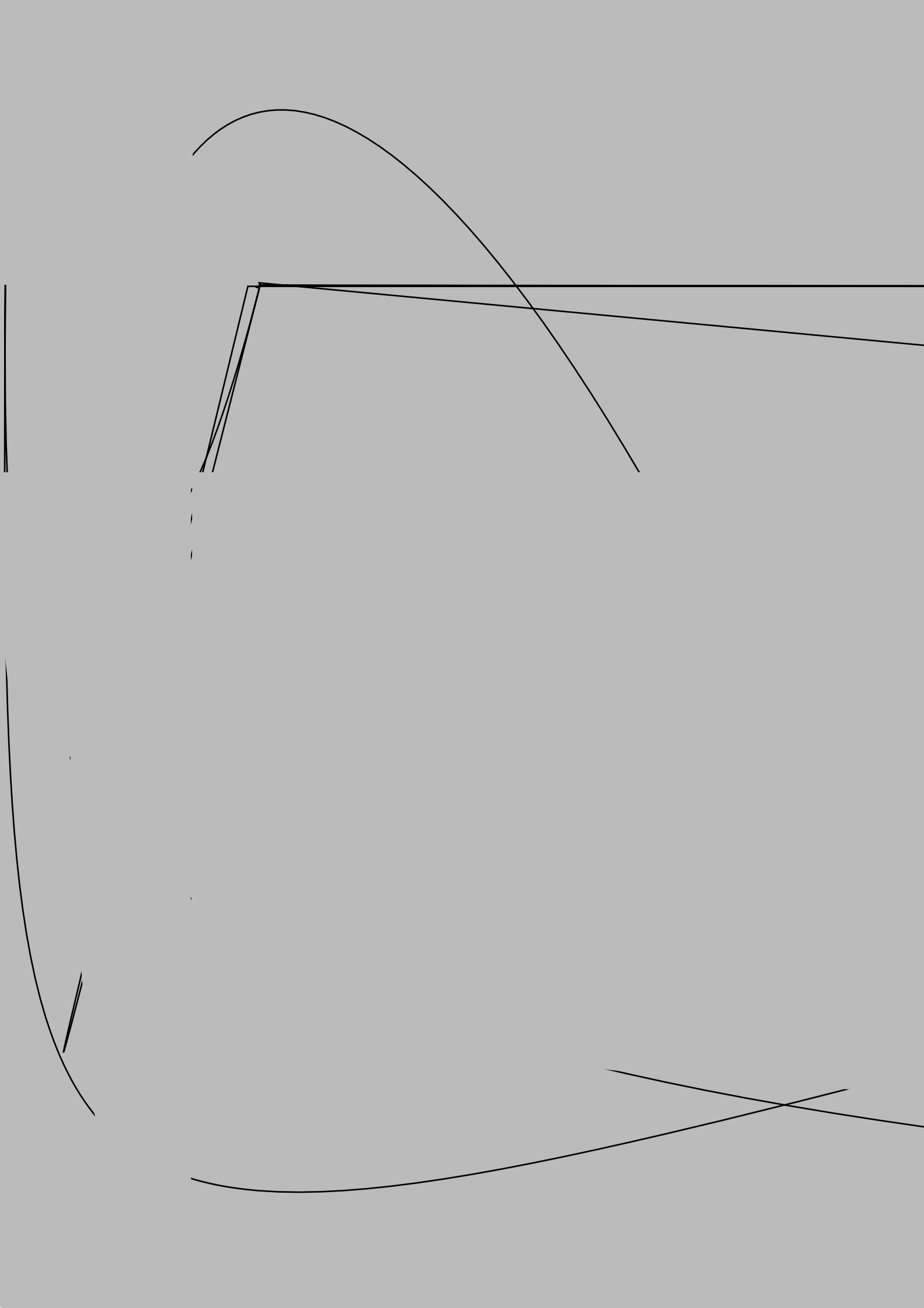

Displaying Images (Photo Viewer) (Continued from the previous page)

Setting an Image as the Background

- 1** Touch the top, bottom, left, or right of the Plus Touch and select the image that you would like to place in the background.

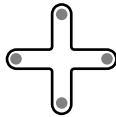

- 2** Press the MENU button.

The Menu window appears.



- 3** Touch the top or bottom of the Plus Touch and select "SET WALLPAPER", then touch the right of the Plus Touch.

The selected image will be set in the background of the screen.

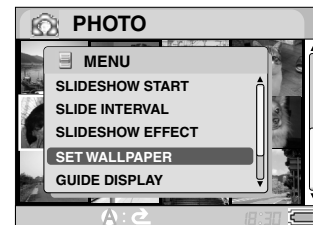
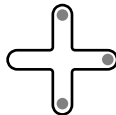

- 4** Touch the top or bottom of the Plus Touch and select any one of "USER 1", "USER 2", and "USER 3", then touch the right of the Plus Touch.

The selected image will be set to the user background, USER 1, or USER 2, or USER 3, and then set to the current background.



Welcome

Getting Ready

Using the Product

Other Helpful Information

Output of Audio from An Audio System

Use of the LINE OUT jack of the USB CRADLE permits playback with any analog device.

- 1** Connect the gigabeat to the USB CRADLE.
- 2** Connect the LINE OUT jack of the USB CRADLE with a PC speaker or another device.
- 3** Set the USB/LINE OUT switch of the USB CRADLE to "LINE OUT".

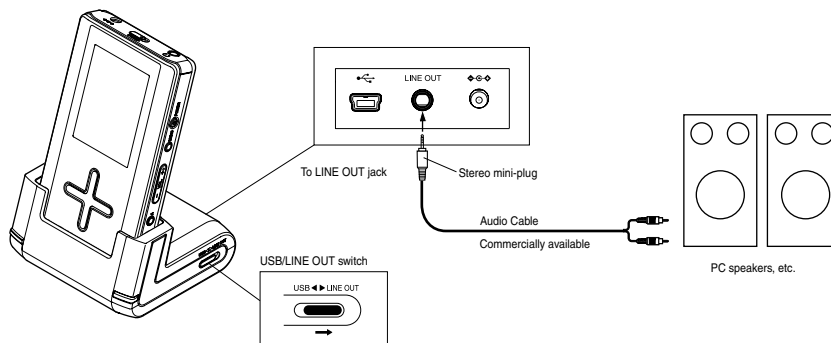

NOTE When changing the USB/LINE OUT switch from **USB** to **LINE OUT**, with USB connected, do so as described below. Close the gigabeat room, then make the change when the gigabeat is not connected to the PC.

When using the LINE OUT jack for output, the equalizer is set to **FLAT** in spite of its setting and display and the **PRESET VOLUME** and **PRESET EQ** (➡ p. 63) have no effect.

Welcome

Getting Ready

Using the Product

Other Helpful Information

Welcome

Getting Ready

Using the Product

Other Helpful Information



1
Connect the digital camera to the USB 1.1 connector (port A) of the USB CRADLE.

2
Turn on gigabeat.

3
Connect the gigabeat to the USB CRADLE.
A screen that prompts whether or not to start the backup will be displayed.

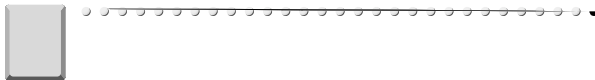

NOTE

Loading can be performed even when there is a change to the order of Steps 1 to 3.

Cancellation is not possible part way through the backup.

When a cable is also connected to the USB 2.0 connector (port B), please set **USB PRIORITY** of the Setup window to **CAMERA**.

Please check the owner's manual of your camera for information about making the USB connections with the digital camera.

You can check whether digital cameras or other devices support USB Mass Storage Class by following the procedure below on the PC.

- 1 Select "Properties" by right-clicking "My Computer icon" on the PC's desktop or right-clicking "My Computer" on the "Start" menu. "System Properties" window will be displayed.
- 2 Select "Hardware" and then select "Device Manager".
- 3 Click "+" of "Universal Serial Bus controllers".
- 4 Connect the PC and the digital camera.

If the connected digital camera supports USB Mass Storage Class, "USB Mass Storage Device" will be displayed newly in the list of "Universal Serial Bus controllers".

(Use the connection cable supplied with the digital camera.)

If "Imaging devices" is displayed, the digital camera supports PTP (Picture Transfer Protocol). In this case, the function in "Backing up Data to the gigabeat" cannot be available.

Welcome

Getting Ready

Using the Product

Other Helpful Information

Track Selection and Playback Sequence

If the folders tree in the gigabeat is as shown below, the playback sequence will follow the rules on the next page.

Folders in the gigabeat

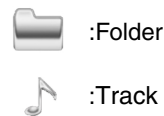
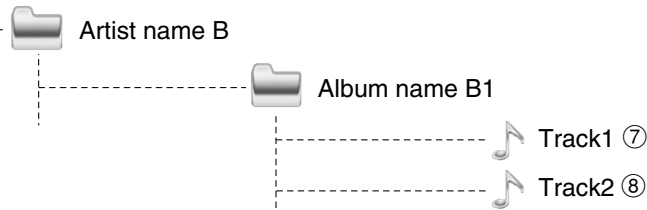
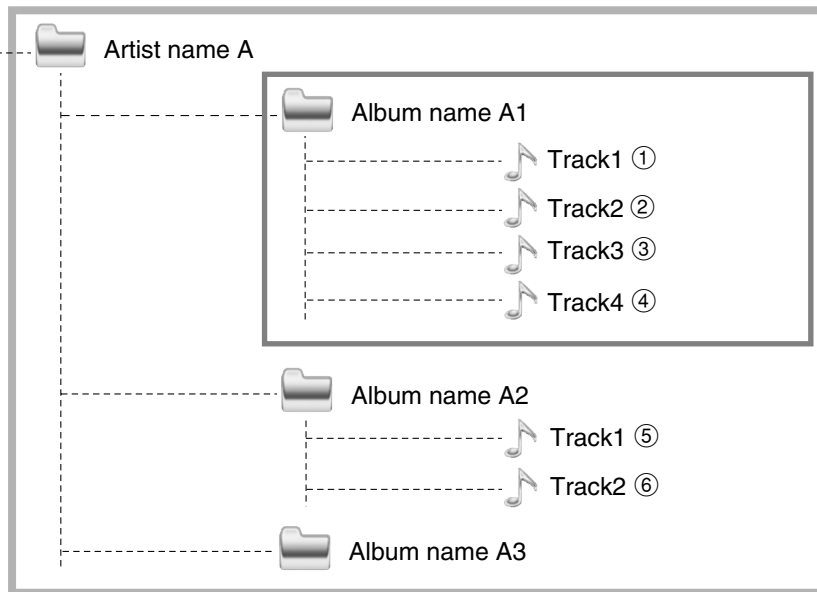



Welcome

Getting Ready

Using the Product

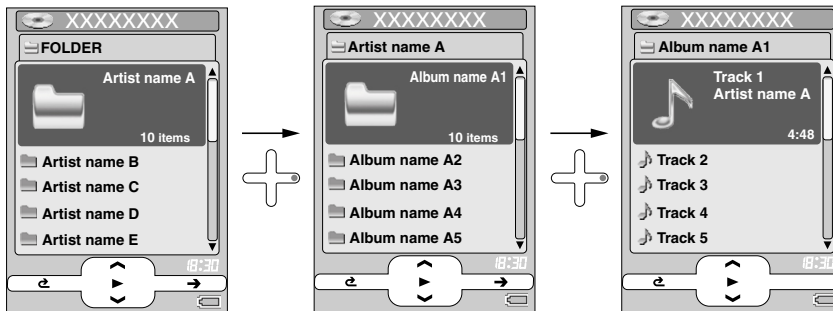
Other Helpful Information



⊕ Touch the center
The track of artist
name A will be played.
Highlighted line 
(➡ p. 60)

⊕ Touch the center
The track of album name
A1 will be played.
Highlighted line 
(➡ p. 60)

⊕ Touch the center
The track1 will be
played.

- If the play mode is **PLAY ALL**, the playback sequence will follow the rules below

When the center of the Plus Touch is touched at the following location	Playback Order
Artist name A	Repeat in the order of ① to ⑥, ⑦, and ⑧
Album name A2	Repeat in the order of ⑤, ⑥, ⑦, ⑧, and ① through ④

- If the play mode is **PLAY ALBUM**, the playback sequence will follow the rules below

When the center of the Plus Touch is touched at the following location	Playback Order
Artist name A	Play in the order of ① to ⑥
Album name A2	Play in the order of ⑤, ⑥
Artist name B	Play in the order of ⑦, ⑧

NOTE The gigabeat can play or display only the track transferred by the gigabeat room, Windows Media Player 10 or Napster.

A maximum of 999 tracks can be played from one folder.

Welcome

Getting Ready

Using the Product

Other Helpful Information

Changing/Checking Settings

The gigabeat allows you to set various items such as play mode and beeper sound. Check the current settings or change to desired settings in the Setup window.

Welcome

- 1** In the **MAIN MENU**, touch the top or bottom of the Plus Touch and select **"SETUP"**, then touch the right of the Plus Touch.

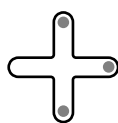

The Setup window appears.



- 2** Touch the top or bottom of the Plus Touch and select the setting item that you would like to change/check, then touch the right of the Plus Touch.



The selections for the selected setting item will be displayed. gigabeat F60_OP62_70(E)ã,100953

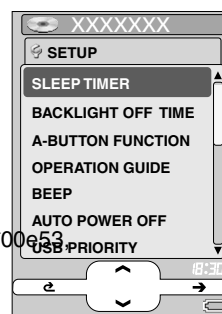

Using the Product

Other Helpful Information

SLEEP TIMER	Select the number of minutes after which the power should turn OFF. Selecting OFF will disable this function.
BACKLIGHT OFF TIME	Selects how many seconds must elapse in a condition without any operations being conducted before the backlight of the screen is automatically turned off or dimmed.
A-BUTTON FUNCTION	Assign button A on the side of the gigabeat to any one of EQUALIZER/SRS WOW, ALBUM SKIP, BOOKMARK, MUTE, and DISPLAY JACKET.
OPERATION GUIDE	Selects whether or not to display the operation guide.
BEEP	Select whether or not to emit a beep sound.
AUTO POWER OFF	In conditions other than during playback or when there is a USB connection, NONE selects how many minutes must elapse without any operations being performed before the power is turned off automatically. When "None" has been selected, this function will not operate.

USB PRIORITY	<p>Selects the operation when cables or adapters have been connected to both the USB 2.0 connector (port B) and USB 1.1 connector (port A).</p> <p>PC: Prioritizes the connection with the PC using a USB cable in the USB 2.0 connector (port B).</p> <p>CAMERA: Prioritizes the connection with a digital camera or other device using a USB cable in USB 1.1 connector (port A).</p>
PC CONNECTIONS	<p>This sets the connection method between the gigabeat and gigabeat room or Windows Media Player 10 on the PC. Connection is via the USB CRADLE (USB connection). When a direct connection has been made with the USB connector of the gigabeat, the operation will be the same as when the setting is made to gigabeat room, regardless of this setting.</p> <p>Windows Media Player 10: This supports the Windows Media Player.</p> <p>gigabeat room: This corresponds to the gigabeat room. Connection can also be made to Windows Media Player 10; however, in this mode Windows Media Player 10 is not supported.</p> <p>SELECT WHEN CONNECT: This is selected when a connection is made with the PC.</p>
PLAY MODE	Select repeat or random. (➡ p. 38)
INTRO	Select the intro playback time. (➡ p. 51)
EQUALIZER/SRS WOW	Select the equalizer mode. (➡ p. 40)
USER SETTING EQ	USER , one type of equalizer, can be set as desired (➡ p. 42)
PRESET EQ	When set to ON , the tone setting that was changed with Edit Track Information of the gigabeat room will be enabled at time of playback.
PRESET VOLUME	When set to ON , the volume setting that was changed with Edit Track Information of the gigabeat room will be enabled at time of playback.
PLUS TOUCH ↑↓	This set the top/bottom operation of the Plus Touch to either the VOLUME operation or the ALBUM SKIP operation.
WALLPAPER	Selects the background.
SCREEN THEME	This selects the screen theme (i.e., the design of the screen, the orientation of the screen display, the size of the display characters, and the size of the cover photograph display area). (➡ p. 52)
SLIDE INTERVAL	This select the interval of the slideshow (in seconds).
SLIDESHOW EFFECT	Select the slideshow effects from among the following. NO EFFECT, FADE(WHITE), FADE(BLACK), WIPE
SORT	Selects whether to sort tracks by track number, name, or date.
TIME FORMAT	Select whether to display the format by 12 hours or 24 hours.
TIMEZONE	Select Time Zone.
DATE/TIME	Set date and time. (➡ p. 65)
SYSTEM	The gigabeat version and the number of files already played will be displayed.
LANGUAGE	Select the display language for the Menu window and error messages. The display language for the Play window and Browse window remains the same.

Welcome

Getting Ready

Using the Product

Other Helpful Information

Changing/Checking Settings (Continued from the previous page)

- 3** Touch the top or bottom of the Plus Touch and select setting, then touch the right of the Plus Touch.

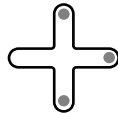

The setting will be changed and a “√” mark will appear to the left of the selection.



- 4** Touch the left of the Plus Touch.

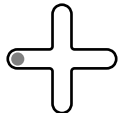

The screen will return to the MAIN MENU.

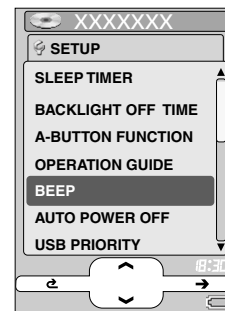

NOTE You can also select **SORT** in the Menu window of the Browse window. When **Windows Media Player 10** has been set with **PC CONNECTIONS** and the connection is via the USB CRADLE, the number of tracks that can be handled is approximately 25,000 tracks.

Setting Time Zone

- 1** Touch the top or bottom of the Plus Touch at the “TIMEZONE” Setting window and select the time zone that you would like to set, then touch the right of the Plus Touch.

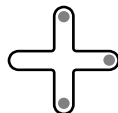

The Time Zone will be set and a “√” mark will appear to the left of the selection.
DST: Daylight Saving Time

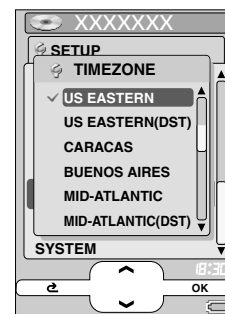

NOTE If you have turned on the power for the first time after purchase, or after a reset, the window to set the **TIMEZONE** will appear. Set the **TIMEZONE** and **DATE/TIME** (➔ p.65).

Terminology

CDDB

This is a database service of song information that is recorded on music CDs. You can get the information from the Internet.

EQUALIZER

This is a device or function that controls the tone by increasing or decreasing the scale of a number of equal frequency bandwidths using a knob or another method.

MP3 (MPEG-1 Audio Layer 3)

An international standard established by MPEG, a working group under the International Standardization Organization (ISO). This standard permits files to be compressed at a scale of 1/10 to 1/12.

Tag Information

This is information such as the song titles, artist's name, album name, and genre which is written to an audio file.

USB Mass Storage Class

This is a standard of peripheral devices which are identified as drives, such as hard disk drives (HDD), when connected. It is also called USB storage class.

WAV

This is a Windows standard non-compressed audio file.

WMA (Windows Media Audio)

This designates the audio-compression coding method developed by Microsoft Corporation or audio files compressed according to this standard.

Welcome

Getting Ready

Using the Product

Other Helpful Information

Error Message List

The gigabeat may display the following error messages. When an error message is displayed, take appropriate action by referring to the instructions below.

Message	Content and Corrective Action
UNSUPPORTED DATA	The format of the selected data cannot be played on the gigabeat. Use the gigabeat room to transfer the data. (Refer to "Transferring Tracks to the gigabeat" in the Owner's Manual-"gigabeat room".)
UNABLE TO READ DISK	Reformat the built-in hard disk to the FAT32 format. Use the gigabeat format. (Refer to "Troubleshooting" in the Owner's Manual-"gigabeat room".)
NO DATA FOUND	Transfer data to the gigabeat. (Refer to "Transferring Tracks to the gigabeat" in the Owner's Manual-"gigabeat room".)
DATA ERROR	The selected data is damaged. Use the gigabeat room to transfer the data again. (Refer to "Transferring Tracks to the gigabeat" in the Owner's Manual-"gigabeat room".)
FAILED TO OPEN	The track could not be opened and played. Use TOSHIBA Audio Application to transfer the data again. (Refer to "Transferring Tracks to the gigabeat" in the Owner's Manual-"gigabeat room".)
RECHARGE BATTERY	There is insufficient power remaining in the built-in battery. Connect the AC adapter and charge the battery. (➡ p. 30)
NO SYSTEM FOUND ON HDD	The gigabeat cannot be started because the firmware on the hard disk has been destroyed. Please restore the firmware. (Refer to "Troubleshooting" in the Owner's Manual-"gigabeat room".)

Welcome

Getting Ready

Using the Product

Other Helpful Information

Troubleshooting

If you experience any of the following issues while using the gigabeat, check the following guide for the possible cause before requesting service.

Issue	Cause	Solution	Reference page
The gigabeat doesn't power up. The button doesn't work.	The BATTERY switch is set to OFF .	Set the BATTERY switch to ON .	30
	There is insufficient power remaining in the built-in battery.	Connect the AC adapter and charge the built-in battery.	30
	The gigabeat is in HOLD mode.	Reset the HOLD switch to cancel the HOLD mode.	20, 23
	The button is not being pressed long enough.	When turning on the power, press the POWER button for two seconds or longer.	33
	The gigabeat is connected to a PC.	The gigabeat cannot be operated while being connected to a PC.	Owner's Manual- "gigabeat room"
The battery is consumed quickly after charge.	The built-in battery has failed.	Replace with a new battery. To replace the built-in battery, contact TOSHIBA Customer Service by calling. (Phone # on "Stop SHEET")	13
Playback cannot be performed.	There is no track.	Use gigabeat room to transfer tracks.	Owner's Manual- "gigabeat room"
There is no sound.	The EARBUDS are not connected properly.	Check the connection between the EARBUDS and wired remote control and main unit.	34
	The volume is set to the minimum.	Adjust the volume.	36
The charge indicator doesn't illuminate, in charging operation.	The BATTERY switch is set to OFF .	Set the BATTERY switch to ON .	30
	The gigabeat is not connected properly.	Check the connection between the AC adapter/AC cable and the main unit.	30
	Outside the specified operating-temperature range.	Charge within the operating-temperature range.	69
The charge indicator turned off while the AC adapter was connected.	The charge is automatically stopped to limit the temperature increase in the gigabeat.	This is a safety feature. Keep the gigabeat in the charging operation. Charging will resume after a while.	32
The PC does not recognize the gigabeat.	The gigabeat is not properly connected to the PC.	Check the connection with the PC.	Owner's Manual- "gigabeat room"

■ Resetting

If the issue cannot be resolved after taking the above corrective actions, reset the main unit by following the steps below:

- 1 Unplug the AC adapter from the main unit.
- 2 Set the BATTERY switch to **OFF** and then set it to **ON** again after approximately five seconds. The play mode and other conditions will return to their initial settings.

Welcome

Getting Ready

Using the Product

Other Helpful Information

Specifications

Built-in battery	Rechargeable lithium-ion battery	
Weight	MEGF60 and MEGF40	Approx. 170 g (main unit only)
	MEGF20 and MEGF10	Approx. 160 g (main unit only)
External dimensions	MEGF60 and MEGF40	Approx. 63 mm x 19 mm x 106 mm (width x height x depth), excluding projections
	MEGF20 and MEGF10	Approx. 63mm x 16 mm x 106 mm (width x height x depth), excluding projections
Audio format	<ul style="list-style-type: none"> ● MPEG-1 Audio Layer 3 (MP3) ● Windows Media Audio (WMA) ● PCM (WAV) 	
Sampling frequency	22.05 to 48 kHz (➡ p. 70)	
Bit rate	16 to 320 kbps (➡ p. 70)	
Recording media	MEGF60	Internal hard disk 60 GB*
	MEGF40	Internal hard disk 40 GB*
	MEGF20	Internal hard disk 20 GB*
	MEGF10	Internal hard disk 10 GB*
Maximum recording time	MEGF60	Approx. 996** hours (at 128 kbps bit rate)
	MEGF40	Approx. 664** hours (at 128 kbps bit rate)
	MEGF20	Approx. 332** hours (at 128 kbps bit rate)
	MEGF10	Approx. 166** hours (at 128 kbps bit rate)
Continuous playback time	Approx. 16 hours** (Built-in battery) Assuming 128 kbps, 44.1 kHz WMA tracks (excluding content protected with Windows Media DRM 10), in normal temperature (25°C), backlight unlit, volume adjusted to center The continuous playback time is a reference value but is not guaranteed, since the actual playback time will vary depending on the operating condition, ambient operating temperature, the number of times the built-battery has been recharged, etc. Even under allowable operating conditions, using the gigabeat at low temperature will result in a reduction of the maximum continuous playback time. WAV tracks consume a lot of battery power, so the continuous playback time of WAV tracks are significantly shorter than when MP3 or WMA tracks are played.	
Operating conditions	Temperature: 5 to 35°C, Humidity: 30 to 80% (RH) (No condensation)	
USB port	USB2.0/USB1.1	
Headphone jack	3.5-mm jack/stereo type Load impedance 16 Ω	
S/N ratio	95 dB or higher	
AC adapter	Input power condition: 100 to 240VAC, 50/60Hz Rated output: 5V DC, 3 A	
Color panel***	2.2 inch diagonal QVGA low temperature polysilicon TFT color panel	

Welcome

Getting Ready

Using the Product

Other Helpful Information

Specifications (Continued from the previous page)

* 1 Gigabyte = 1 billion bytes when referring to hard drive capacity. Available storage capacity will also be less if the product includes pre-installed operating system and/or application software. Actual formatted capacity may vary.

** These values are for reference purposes only and may vary.

***The color LCD is made with extremely high-precision technology. There may be the existence of display (pixels) that might not light or might be lit all the time; however, please note that this does not constitute malfunction of the product and is not covered by your warranty.

■ Combination of Sampling Frequency and Bit Rate

The tracks that can be played on the gigabeat have the following combinations of sampling frequency and bit rate. Tracks with another combination may not play properly.

- MP3 (stereo)

Sampling frequency:	22.05, 44.1, 48 kHz
Bit rate:	32 to 320 kbps
- MP3 (mono)

Sampling frequency:	22.05, 44.1, 48 kHz
Bit rate:	16 to 64 kbps
- WMA (stereo)

Sampling frequency:	22.05/44.1 kHz
Bit rate:	32/48 to 192 kbps
- WMA (mono)

Sampling frequency:	44.1 kHz
Bit rate:	32 kbps
- WAV (stereo/mono)

Sampling frequency:	22.05, 44.1, 48 kHz
Bits:	16 bits

NOTE

This product complies with the above specifications. Designs and specifications are subject to change without notice. This product may not be compatible with features and/or specifications that may be added in the future.

The illustrations and screen displays appearing in this manual may differ somewhat from the actual appearance for the purpose of easy viewing.

The display position and other aspects of the icons are subject to change.

License Information on the Software Used in the TOSHIBA Mobile Audio Player

The software pre-installed in the TOSHIBA Mobile Audio Player consists of multiple, independent software components. Each software component is copyrighted by TOSHIBA or a third party.

The TOSHIBA Mobile Audio Player uses software components that are distributed as freeware under a third-party end-user license agreement or copyright notice (hereinafter referred to as a "EULA").

Some EULAs require that the source code of the applicable component be disclosed as the condition for distributing the software component in executable format. You can check the software components subject to such EULA requirements on the following website:

Website: <http://www.gigabeat.net/mobileav/audio/eula/>

The software components of the TOSHIBA Mobile Audio Player also include software developed or created independently by TOSHIBA. Such software and accompanying documents are owned by TOSHIBA and protected under copyright laws, international treaty provisions and other governing laws. See the attached "Software License Agreement" for the terms and conditions governing the use of software components owned by TOSHIBA. Source code is not disclosed for the software components developed or created independently by TOSHIBA that are not subject to any EULA.

TOSHIBA provides a warranty for the TOSHIBA Mobile Audio Player you have purchased under conditions set forth by TOSHIBA.

However, some of the software components distributed under an EULA are made available for use by the user on the assumption that they are not copyrighted or warranted by TOSHIBA or any third party. These software components are licensed to the user free of charge and therefore not covered by any warranty within the scope of the applicable laws. These software components are not subject to any copyrights or other third-party rights and are provided in "as is" condition without any warranty, whether express or implied. "Warranty" here includes, but not limited to, an implied warranty for marketability or fitness for specific uses. All risks associated with the quality or performance of these software components are assumed by the user. TOSHIBA shall not be liable whatsoever for any cost of repair or correction or other incidental expense incurred in connection with a defect found in any of these software components. Unless specified under the applicable laws or in a written agreement, a party who changes or redistributes the software with consent from the copyright holders or based on the aforementioned licenses shall not be held liable whatsoever for any loss arising from the use of or inability to use such software components. The same applies even when the copyright holders or relevant third parties have been informed of the possibility of such loss. "Loss" here includes normal, special, incidental and indirect loss (including, but not limited to, the loss of data or its accuracy; loss incurred by the user or any third party; and interface incompatibility with other software). Please read each EULA for details on the use conditions and items that must be observed regarding these software components.

The table below lists the software components pre-installed in the TOSHIBA Mobile Audio Player, which are subject to EULAs. The user should read the applicable EULAs carefully before using these software components. The EULAs are attached to the supplied CD-ROM in their original text (English) as exactly written by the respective parties other than TOSHIBA.

Applicable software module	Reference section
Linux kernel, Busybox, Samba, linux-wlan, dhcpcd	Original Text (English) of the End User License Agreement Relating to the Freeware Components Used in the TOSHIBA Mobile Audio Player (CD-ROM)\GPL\gpl.txt
glibc	Original Text (English) of the End User License Agreement Relating to the Freeware Components Used in the TOSHIBA Mobile Audio Player (CD-ROM)\GPL\gpl.txt

Limited United States Warranty MEG-F Series Mobile Audio Player - Depot Repair Warranty

Toshiba America Consumer Products, L.L.C. ("TACP") makes the following limited warranties to original consumers in the United States.

THESE LIMITED WARRANTIES EXTEND TO THE ORIGINAL CONSUMER PURCHASER OR ANY PERSON RECEIVING THIS MEG-F SERIES MOBILE AUDIO PLAYER AS A GIFT FROM THE ORIGINAL CONSUMER PURCHASER AND TO NO OTHER PURCHASER OR TRANSFEREE.

MEG-F SERIES MOBILE AUDIO PLAYERS PURCHASED IN THE U.S.A. AND USED ANYWHERE OUTSIDE OF THE U.S.A., INCLUDING, WITHOUT LIMITATION, CANADA AND MEXICO, ARE NOT COVERED BY THESE WARRANTIES.

MEG-F SERIES MOBILE AUDIO PLAYERS PURCHASED ANYWHERE OUTSIDE OF THE U.S.A., INCLUDING, WITHOUT LIMITATION, CANADA AND MEXICO, AND USED IN THE U.S.A., ARE NOT COVERED BY THESE WARRANTIES.

Limited One (1) Year Warranty on Parts and Labor

TACP warrants this MEG-F Series Mobile Audio Player and its parts against defects in materials or workmanship for period of one (1) year after the date of original retail purchase.

DURING THIS PERIOD, TACP WILL, AT TACP'S OPTION, REPAIR OR REPLACE A DEFECTIVE PART WITH A NEW OR REFURBISHED PART WITHOUT CHARGE TO YOU.

Rental Units

The warranty for MEG-F Series Mobile Audio Player rental units begins on the date of the first rental or thirty (30) days after the date of shipment to the rental firm, whichever comes first.

Commercial Units

MEG-F Series Mobile Audio Players sold and used for commercial purposes have a limited warranty for all parts and labor, which warranty begins on the date of original retail purchase and ends on the date that is ninety (90) days thereafter.

Owner's Manual and Product Registration Card

Read this owner's manual thoroughly before operating this MEG-F Series Mobile Audio Player.

Complete and mail the enclosed product registration card or register your MEG-F Series Mobile Audio Player online at www.tacp.toshiba.com/service as soon as possible. By registering your MEG-F Series Mobile Audio Player you will enable TACP to bring you new products specifically designed to meet your needs and help us to contact you in the unlikely event a safety notification is required under the U.S. Consumer Product Safety Act. Failure to complete and return the product registration card does not diminish your warranty rights.

Your Responsibility

THE ABOVE WARRANTIES ARE SUBJECT TO THE FOLLOWING CONDITIONS:

- (1) You must retain your bill of sale or provide other proof of purchase.
- (2) All warranty servicing of this MEG-F Series Mobile Audio Player must be made by the Depot Warranty Repair Center specified by the TACP Consumer Solutions Center.
- (3) The warranties from TACP are effective only if this MEG-F Series Mobile Audio Player is purchased and operated in the Continental U.S.A. or Puerto Rico.
- (4) Labor service charges for set installation, setup, adjustment of customer controls and installation or repair of antenna systems are not covered by this warranty. Reception problems caused by inadequate antenna systems are your responsibility.
- (5) Warranties extend only to defects in materials or workmanship as limited above, and do not extend to any MEG-F Series Mobile Audio Player or parts that have been lost or discarded by you or to damage to the MEG-F Series Mobile Audio Player or parts caused by fires, misuse, accident, Acts of God (such as lightning or fluctuations in electric power), improper installation, improper maintenance, or use in violation of instructions furnished by TACP; use or malfunction through simultaneous use of this MEG-F Series Mobile Audio Player and connected equipment; or to units that have been modified or had the serial number removed, altered, defaced, or rendered illegible.

How to Obtain Warranty Services

If, after following all of the operating instructions in this manual and reviewing the section entitled “Troubleshooting”, you find that service is needed:

- (1) For instructions on how to obtain warranty service for your MEG-F Series Mobile Audio Player, contact TACP’s Consumer Solution Center toll free at 1-800-631-3811.
- (2) You must include a copy or original bill of sale or other proof of purchase along with the entire MEG-F Series Mobile Audio Player to the Depot Warranty Repair Center specified by the TACP Consumer Solutions Center. You are responsible for all inbound transportation and insurance charges for the MEG-F Series Mobile Audio Player to the Depot Warranty Repair Center specified by the TACP Consumer Solutions Center.

For additional information, visit TACP’s website: www.tacp.toshiba.com

ALL WARRANTIES IMPLIED BY THE LAW OF ANY STATE OF THE U.S.A., INCLUDING THE IMPLIED WARRANTIES OF MERCHANTABILITY AND FITNESS FOR A PARTICULAR PURPOSE, ARE EXPRESSLY LIMITED TO THE DURATION OF THE LIMITED WARRANTIES SET FORTH ABOVE. WITH THE EXCEPTION OF ANY WARRANTIES IMPLIED BY THE LAW OF ANY STATE OF THE U.S.A. AS HEREBY LIMITED, THE FOREGOING WARRANTY IS EXCLUSIVE AND IN LIEU OF ALL OTHER WARRANTIES, GUARANTEES, AGREEMENTS, AND SIMILAR OBLIGATIONS OF TACP WITH RESPECT TO THE REPAIR OR REPLACEMENT OF ANY PARTS.

IN NO EVENT SHALL TACP BE LIABLE FOR CONSEQUENTIAL OR INCIDENTAL DAMAGES (INCLUDING, BUT NOT LIMITED TO, LOST PROFITS, BUSINESS INTERRUPTION, OR MODIFICATION OR ERASURE OF RECORDED DATA CAUSED BY USE, MISUSE OR INABILITY TO USE THIS MEG-F SERIES MOBILE AUDIO PLAYER).

No person, agent, distributor, dealer or company is authorized to change, modify or extend the terms of these warranties in any manner whatsoever. The time within which an action must be commenced to enforce any obligation of TACP arising under the warranty or under any statute, or law of the United States or any state thereof, is hereby limited to ninety (90) days from the date you discover or should have discovered, the defect. This limitation does not apply to implied warranties arising under state law.

THIS WARRANTY GIVES YOU SPECIFIC LEGAL RIGHTS AND YOU MAY ALSO HAVE OTHER RIGHTS WHICH MAY VARY FROM STATE TO STATE IN THE U.S.A. SOME STATES OF THE U.S.A. DO NOT ALLOW LIMITATIONS ON HOW LONG AN IMPLIED WARRANTY LASTS, WHEN AN ACTION MAY BE BROUGHT, OR THE EXCLUSION OR LIMITATION OF INCIDENTAL OR CONSEQUENTIAL DAMAGES, SO THE ABOVE PROVISIONS MAY NOT APPLY TO YOU UNDER SUCH CIRCUMSTANCES.



TOSHIBA

© TOSHIBA CORPORATION 2005

